

Hinge, aluminum

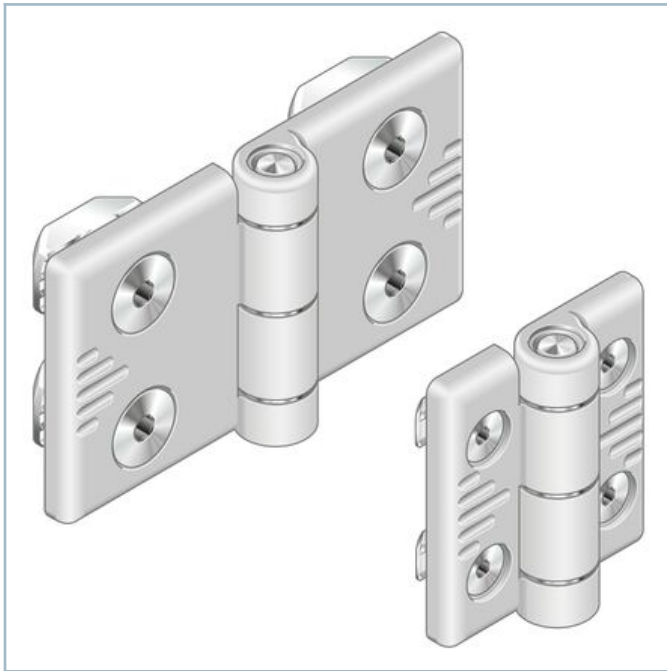

- Aluminum hinge for all slot systems
- Assembly possible on solid surface elements
- High-quality version
- Conductive version
- Suitable for use under clean room conditions thanks to abrasion-resistant guide bushings

Product description

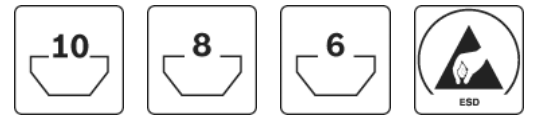
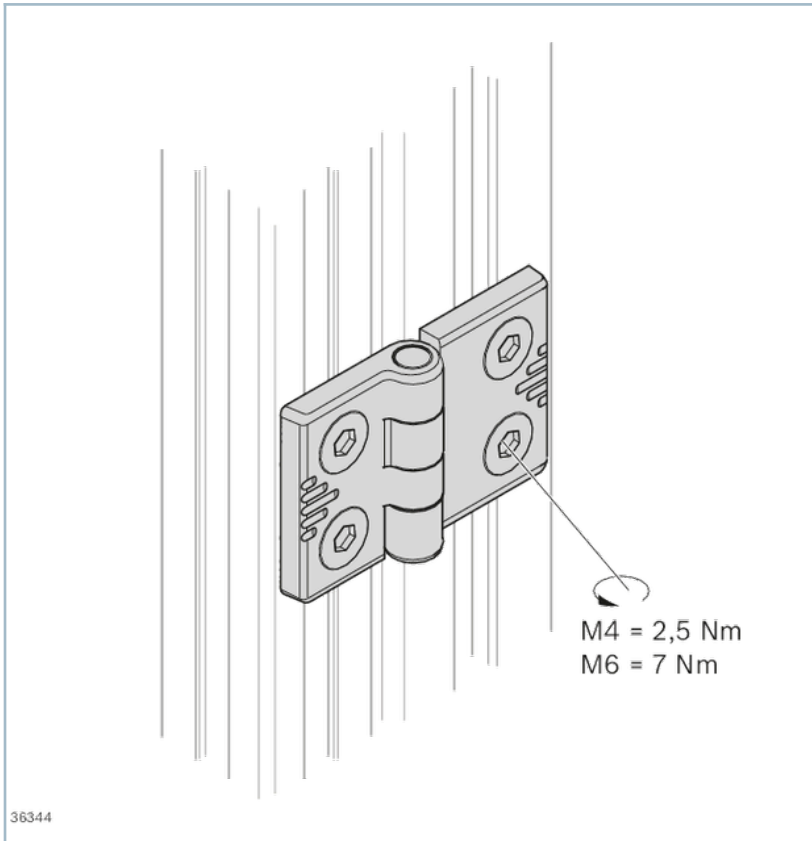

Technical data

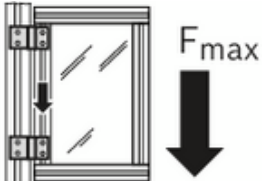
| | | | |
|--|----------|---|-----|
| | Groove |  | N |
| | 6; 8; 10 | | 300 |

| No. | Material |
|------------|---|
| 3842544525 | diecast aluminum; nickel-plated Fastening material: Steel; zinc-plated |

| No. | Material |
|------------|---|
| 3842544526 | diecast aluminum; nickel-plated Fastening material: Steel; zinc-plated |
| 3842544527 | |
| 3842544528 | |
| 3842544529 | |
| 3842544530 | |
| 3842544531 | |

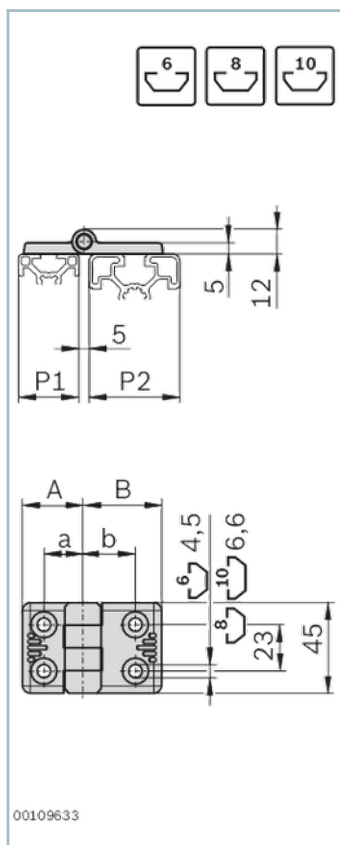

Dimensions

Hinge, aluminum













| P2 | P1 | P1/P2 | A/B | a/b |
|----|----|-------|-----|------|
| | | mm | mm | mm |
| 20 | 20 | 20 | 20 | 12.5 |
| 30 | | 30 | 28 | 17.5 |
| 40 | 30 | | | |
| 45 | | | | |
| 40 | 40 | 40 | 37 | 22.5 |
| 45 | 45 | 45 | 40 | 25 |

Delivery notes

| FS1 | FS2 | FS3 |
|--|---|---|
|  <p>DIN 7991 M4x8</p> |  <p>DIN 7991 M6x12</p> |  <p>DIN 7991 M6x16</p> |









Fastening material

| | | | | |
|------------|----|---|----|---|
| 3842544525 | 4x |  <p>DIN 7991 M4x8</p> | | |
| 3842544526 | 2x |  <p>DIN 7991 M4x8</p> | 2x |  <p>DIN 7991 M6x12</p> |
| 3842544527 | 4x |  <p>DIN 7991 M6x12</p> | | |
| 3842544528 | 2x |  <p>DIN 7991 M6x12</p> | 2x |  <p>DIN 7991 M6x16</p> |
| 3842544529 | 2x |  <p>DIN 7991 M6x12</p> | 2x |  <p>DIN 7991 M6x16</p> |
| 3842544530 | 4x |  <p>DIN 7991 M6x16</p> | | |
| 3842544531 | 4x |  <p>DIN 7991 M6x16</p> | | |

Scope of delivery

| | |
|-----------------------------|-------------------------------|
| Hinge, aluminum P1=20 P2=20 | incl. fastening material (FS) |
| Hinge, aluminum P1=20 P2=30 | |
| Hinge, aluminum P1=30 P2=30 | |
| Hinge, aluminum P1=30 P2=40 | |
| Hinge, aluminum P1=30 P2=45 | |
| Hinge, aluminum P1=40 P2=40 | |
| Hinge, aluminum P1=45 P2=45 | |

Ordering codes

| | Groove | P1 | P2 |  | ESD | FS | No. |
|-----------------------------|----------|----|----|---|--|--------------|------------|
| Hinge, aluminum P1=20 P2=20 | 6; 8; 10 | 20 | 20 | 2 |  | 4xFS1 | 3842544525 |
| Hinge, aluminum P1=20 P2=30 | 6; 8; 10 | 20 | 30 | 2 |  | 2xFS1, 2xFS2 | 3842544526 |
| Hinge, aluminum P1=30 P2=30 | 6; 8; 10 | 30 | 30 | 2 |  | 4xFS2 | 3842544527 |
| Hinge, aluminum P1=30 P2=40 | 6; 8; 10 | 30 | 40 | 2 |  | 2xFS2, 2xFS3 | 3842544528 |
| Hinge, aluminum P1=30 P2=45 | 6; 8; 10 | 30 | 45 | 2 |  | 2xFS2, 2xFS3 | 3842544529 |
| Hinge, aluminum P1=40 P2=40 | 6; 8; 10 | 40 | 40 | 2 |  | 4xFS3 | 3842544530 |
| Hinge, aluminum P1=45 P2=45 | 6; 8; 10 | 45 | 45 | 2 |  | 4xFS3 | 3842544531 |