

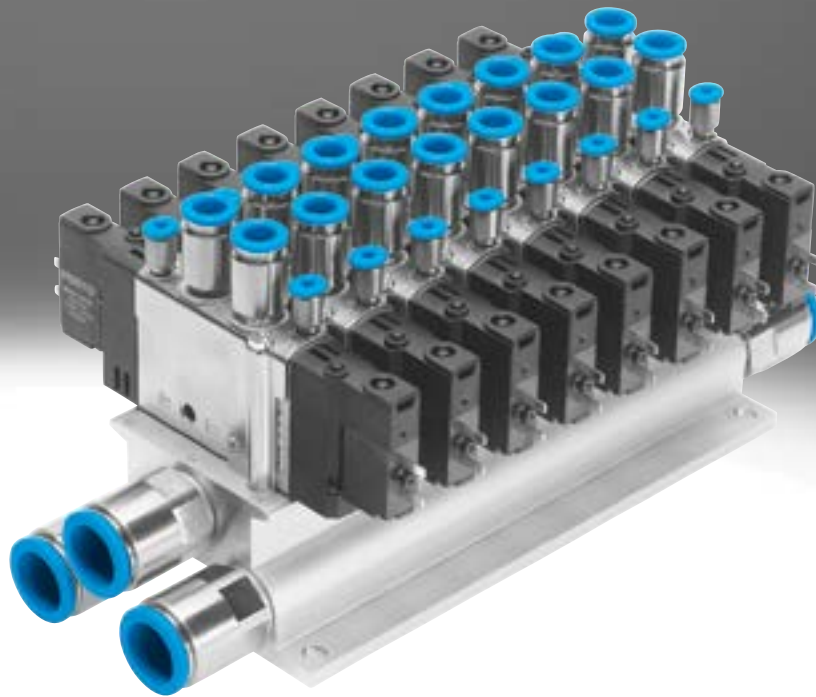

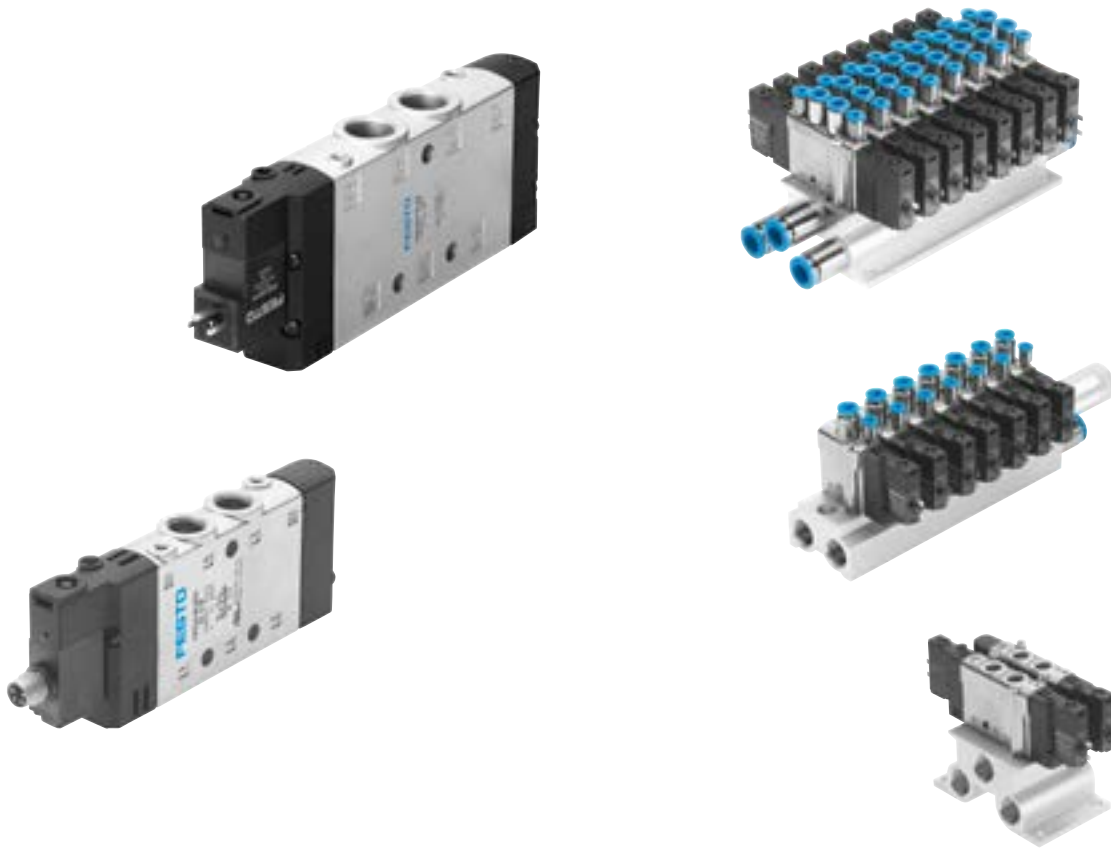

## Universal valve CPE

**FESTO**



Key features



| Variants  | Parameter  | Advantages  |   |
|---|--|---|---|
| <p>Functions (selection)</p> <p>3/2-way valve with external pilot air supply, normally closed</p> | <p>-  - Width<br/>10 mm<br/>14 mm<br/>18 mm<br/>24 mm</p> <p>-  - Flow rate<br/>180 ... 3200 l/min</p>   | <p>Performance-optimised sizes:<br/>The solenoid valves CPE, Compact Performance, are distinguished by their minimal width and low power consumption at high flow rates.</p> <p>They can be mounted directly on site:</p> <ul style="list-style-type: none"> <li>• On the cylinder</li> <li>• On moving system components</li> <li>• Flexible installation through individual mounting</li> </ul> | <p>Short tubing lengths requiring minimal air volume:</p> <ul style="list-style-type: none"> <li>• Short switching times</li> <li>• Very short reaction times</li> </ul> <p>Optimised installations:</p> <ul style="list-style-type: none"> <li>• Shorter machine cycles</li> <li>• Larger quantities</li> <li>• Low power consumption</li> </ul> |
| <p>5/2-way single solenoid valve with internal pilot air supply</p>                               |  |   |   |
| <p>5/2-way double pilot valve with external pilot air supply</p>                                  |  | <p>CPE10, CPE14 and CPE18:<br/>Simple manifold design consisting of fixed-grid manifold blocks made from stable aluminium with 2 to 10 valve positions or modular manifold blocks made from durable polymer.</p>  | <p>The connecting cables NEBV for sizes CPE10 and CPE14 have integrated current reduction.<br/>All CPE valves therefore have a duty cycle of 100%.</p>  |
| <p>5/3-way valve with external pilot air supply, normally closed</p>                              | <p>-  - <b>Note</b><br/>The 5/3-way solenoid valve remains in the previous switching position if both solenoid coils are energised simultaneously.<br/>If neither solenoid coil is energised, the spring force moves the valve to its mid-position.</p> |   |   |

## Key features

### Solenoid valves with plug pins

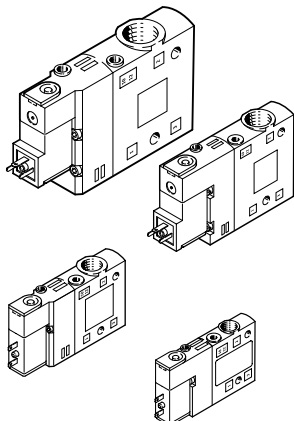

- Width 10 mm, 14 mm, 18 mm and 24 mm
- 3/2-, 5/2- and 5/3-way valves
- Internal or external pilot air supply available
- 24 V DC for all widths
- 110 or 220 V AC for widths 18 and 24
- Manual override, non-detenting and detenting via tool
- Width 10 mm available with M5 insert
- All widths available with QS fittings in 2 sizes

### Solenoid valves with round plug

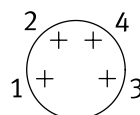
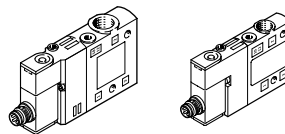

- Widths 10 mm and 14 mm
- 3/2-, 5/2- and 5/3-way valves
- Internal or external pilot air supply available
- 24 V DC
- Manual override, non-detenting and detenting via tool
- Round plug, M8x1, 4-pin

### CPE18 basic valve with interface to ISO 15218

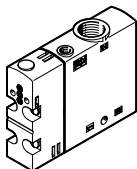

- Width 18 mm
- 3/2-, 5/2- and 5/3-way valves
- Internal or external pilot air supply available

### Pilot valve with interface to ISO 15218

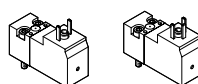

- For 12, 24 V DC and 24 V AC without PE conductor
- For 110 and 220 V AC with PE conductor
- 3/2-way valve
- Manual override non-detenting

### Adapter VAVE

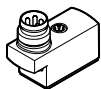

Fits plug pins with plug pattern ZC for CPE10/CPE14

### Combination of basic valve CPE18 with pilot valve

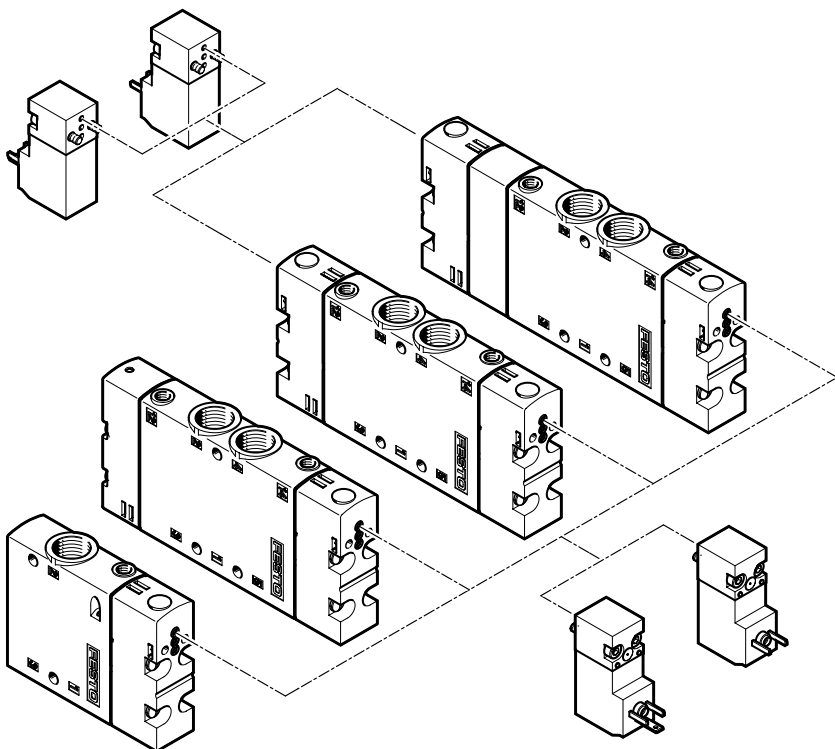

## Key features

### Manifold block for fixed-grid manifold

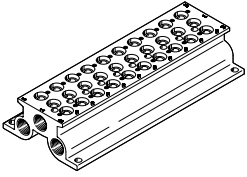

- For valve widths 10, 14 and 18 mm
- For 5/2- and 5/3-way valves
- 2 to 10 valve positions

### Manifold block for fixed-grid manifold

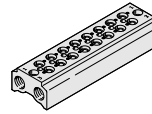

- For valve widths 10, 14 and 18 mm
- For 3/2-way valves
- 2 to 10 valve positions

### Retaining bracket set



- Retaining bracket for 5/2 or 5/3-way valve

### Retaining bracket set

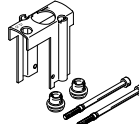

- Retaining bracket for 3/2-way valve

### Cover plate for vacant position

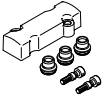

- Reserved position cover for 5/2- or 5/3-way valve

### Cover plate for vacant position



- Reserved position cover for 3/2-way valve

### Manifold block with air supply

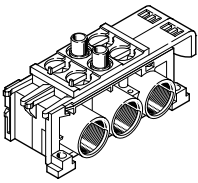

- 2 valve positions
- For CPE10, CPE14 or CPE18
- For 5/2- and 5/3-way valves
- Ducts 1, 3 and 5 can have closed or open ends
- Ducts closed when the manifold is full or when pressure zones are being used

### Manifold block for expansion

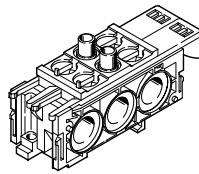

- 2 valve positions
- For CPE10, CPE14 or CPE18
- For 5/2- and 5/3-way valves
- Ducts 1, 3 and 5 can have closed or open ends

### Manifold block with air supply

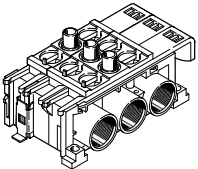

- 3 valve positions
- For CPE10, CPE14 or CPE18
- For 5/2- and 5/3-way valves
- Ducts 1, 3 and 5 can have closed or open ends
- Ducts closed when the manifold is full or when pressure zones are being used

### End plate for additional air supply

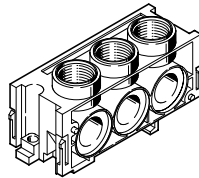

- For CPE10, CPE14 or CPE18
- Required for manifolds with more than 6 valves or separate pressure zones
- Ports 1, 3 and 5 at rear and on top

### Cover plate for vacant position

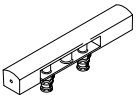

- Versions
- Reserved position cover for 5/2- or 5/3-way valve

### Modular manifold block with cover plate

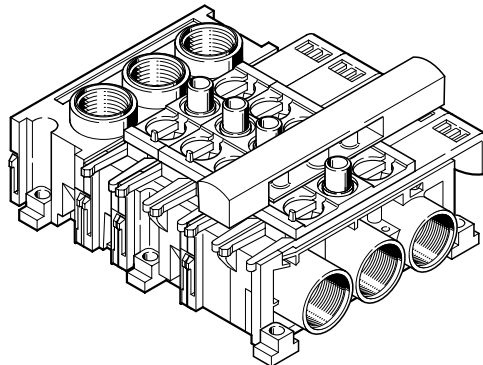

Key features

**Mounting on fixed-grid manifold block for CPE10, CPE14 and CPE18**

- Simple design comprising compact valve manifold assemblies with in-line valves
- Mounting with stable retaining bracket and special moulded seal guarantee leak-free assembly
- 2 to 10 valve positions
- Aluminium mounting rail provides high stability
- High flow rates with air supply on both sides for duct 1
- High exhaust capacity with output on both sides for ducts 3 and 5
- Different pressure and exhaust zones can be created using separators, which are clamped at the separation points in ducts 1, 3 and 5

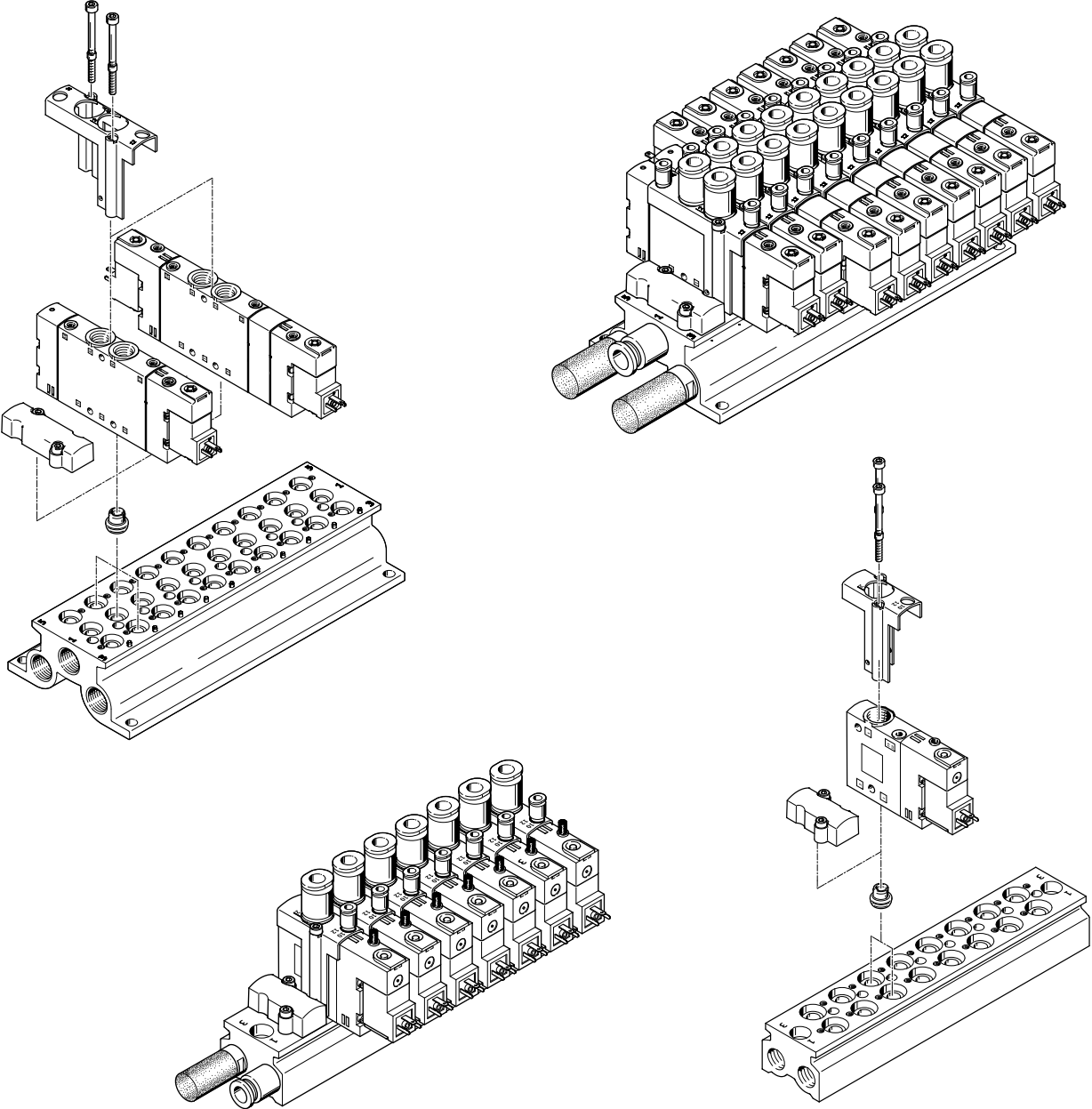

## Key features

### Mounting on fixed-grid manifold block for CPE10, CPE14 and CPE18

- Creating a valve manifold with modular manifold blocks made from high impact, glass fibre reinforced polyamide
- Different pressure zones can be created using basic and expansion blocks with closed supply and exhaust ducts
- Air supply and exhaust can be connected on both sides using an additional end block
- Air supply and exhaust can be connected to the end block, at the rear and at the top
- No screws required for mounting thanks to slides and clips

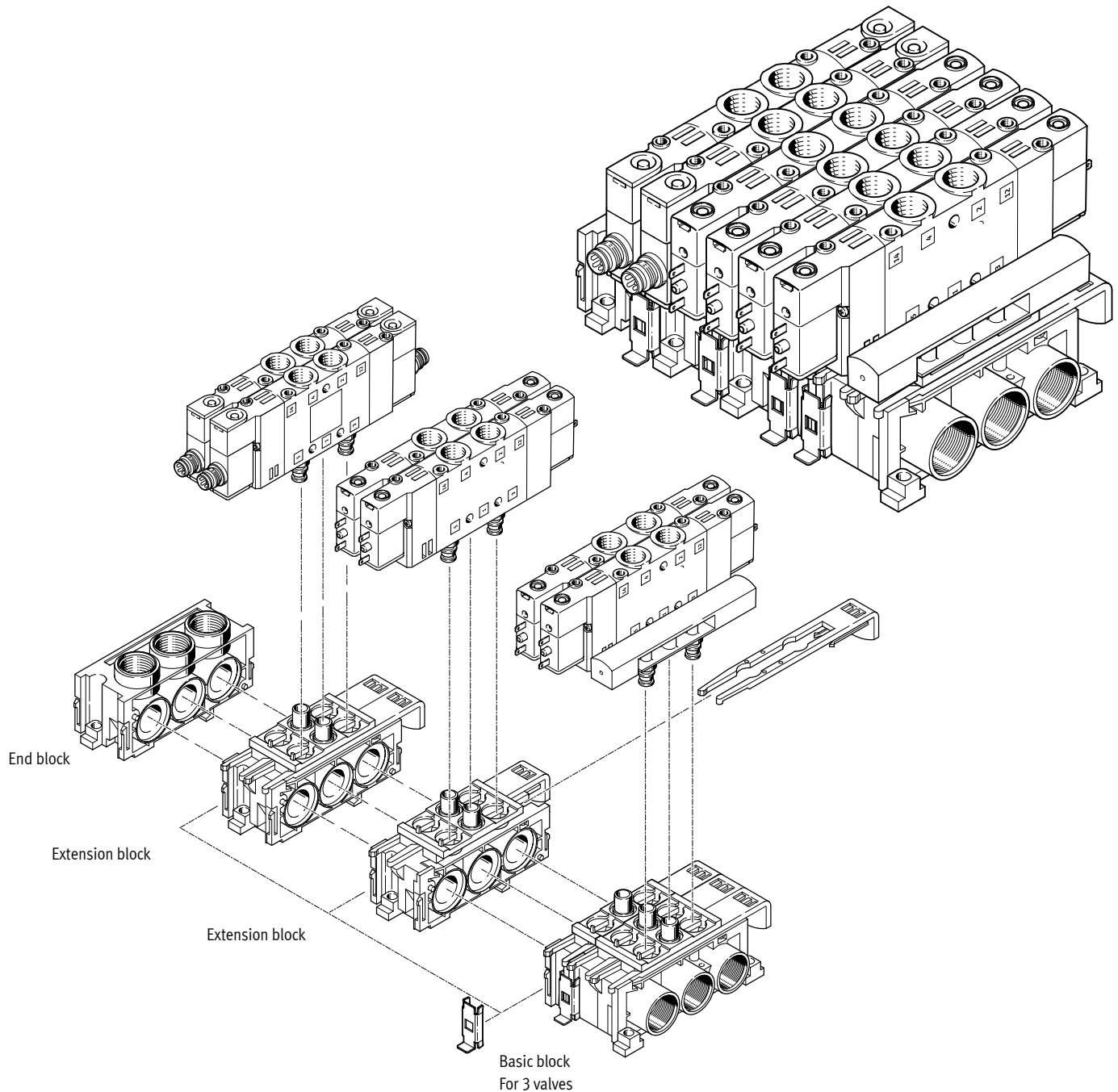

## Key features – Mounting

### Individual valve mounting CPE

#### Cylinder mounting

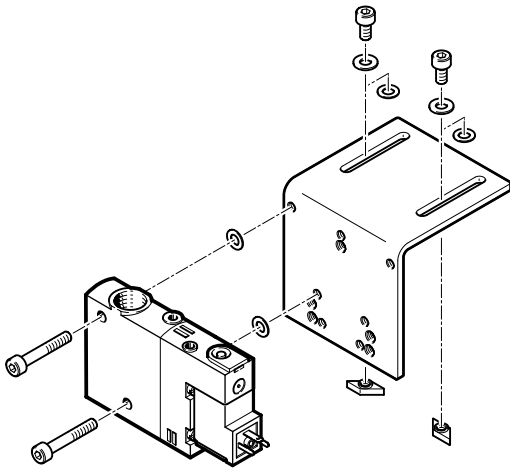

For mounting individual valves directly on a drive.

The solenoid valves are provided with two through-holes for attaching to the cylinder mounting DAVM-MW-V1...-V. Mounting is only possible on the side on which the pneumatic connections are located.







The relevant screw set is included when the cylinder mounting DAVM-MW-V1...-V is ordered.

Product range overview – Widths 10 mm and 14 mm

| Width   | Circuit symbol   | Type               | Electrical connection |      | Operating voltage<br>[V DC] | Working port |    |      |     |     |     | → Page/<br>Internet |
|---|--|--------------------|-----------------------|------|-----------------------------|--------------|----|------|-----|-----|-----|---------------------|
|   |  |                    | Plug pattern ZC       | M8x1 |                             | M5           | M7 | G1/8 | QS4 | QS6 | QS8 |                     |
| 10 mm   | <b>3/2-way single solenoid valve, normally closed</b>              |                    |                       |      |                             |              |    |      |     |     |     |                     |
|   |  | CPE10-M1BH-3GL...  | ■                     | -    | 24                          | ■            | ■  | -    | ■   | ■   | -   | 26                  |
|   |  | CPE10-M1CH-3GL...  | -                     | ■    | 24                          | -            | ■  | -    | -   | -   | -   | -                   |
|   | <b>3/2-way single solenoid valve, normally open</b>                |                    |                       |      |                             |              |    |      |     |     |     |                     |
|   |  | CPE10-M1BH-3OL...  | ■                     | -    | 24                          | ■            | ■  | -    | ■   | ■   | -   | 26                  |
|   |  | CPE10-M1CH-3OL...  | -                     | ■    | 24                          | -            | ■  | -    | -   | -   | -   | -                   |
|   | <b>5/2-way single solenoid valve</b>                               |                    |                       |      |                             |              |    |      |     |     |     |                     |
|   |  | CPE10-M1BH-5L...   | ■                     | -    | 24                          | ■            | ■  | -    | ■   | ■   | -   | 26                  |
|   |  | CPE10-M1CH-5L...   | -                     | ■    | 24                          | -            | ■  | -    | -   | -   | -   | -                   |
|   | <b>5/2-way double solenoid valve</b>                               |                    |                       |      |                             |              |    |      |     |     |     |                     |
|   |  | CPE10-M1BH-5J...   | ■                     | -    | 24                          | ■            | ■  | -    | ■   | ■   | -   | 26                  |
|   |  | CPE10-M1CH-5J...   | -                     | ■    | 24                          | -            | ■  | -    | -   | -   | -   | -                   |
|   | <b>5/3-way solenoid valve, normally closed, mid-position valve</b> |                    |                       |      |                             |              |    |      |     |     |     |                     |
|   |  | CPE10-M1BH-5/3G... | ■                     | -    | 24                          | ■            | ■  | -    | ■   | ■   | -   | 27                  |
| CPE10-M1CH-5/3G...  |  | -                  | ■                     | 24   | -                           | ■            | -  | -    | -   | -   | -   |                     |
| <b>5/3-way solenoid valve, normally open, mid-position valve</b>      |  |                    |                       |      |                             |              |    |      |     |     |     |                     |
|   | CPE10-M1BH-5/3B...   | ■                  | -                     | 24   | ■                           | ■            | -  | ■    | ■   | -   | 27  |                     |
|   | CPE10-M1CH-5/3B...   | -                  | ■                     | 24   | -                           | ■            | -  | -    | -   | -   | -   |                     |
| <b>5/3-way solenoid valve, normally exhausted, mid-position valve</b> |  |                    |                       |      |                             |              |    |      |     |     |     |                     |
|   | CPE10-M1BH-5/3E...   | ■                  | -                     | 24   | ■                           | ■            | -  | ■    | ■   | -   | 27  |                     |
|   | CPE10-M1CH-5/3E...   | -                  | ■                     | 24   | -                           | ■            | -  | -    | -   | -   | -   |                     |
| 14 mm   | <b>3/2-way single solenoid valve, normally closed</b>              |                    |                       |      |                             |              |    |      |     |     |     |                     |
|   |  | CPE14-M1BH-3GL...  | ■                     | -    | 24                          | -            | -  | ■    | -   | ■   | ■   | 43                  |
|   |  | CPE14-M1CH-3GL...  | -                     | ■    | 24                          | -            | -  | ■    | -   | -   | -   | -                   |
|   | <b>3/2-way single solenoid valve, normally open</b>                |                    |                       |      |                             |              |    |      |     |     |     |                     |
|   |  | CPE14-M1BH-3OL...  | ■                     | -    | 24                          | -            | -  | ■    | -   | ■   | ■   | 43                  |
|   |  | CPE14-M1CH-3OL...  | -                     | ■    | 24                          | -            | -  | ■    | -   | -   | -   | -                   |
|   | <b>5/2-way single solenoid valve</b>                               |                    |                       |      |                             |              |    |      |     |     |     |                     |
|   |  | CPE14-M1BH-5L...   | ■                     | -    | 24                          | -            | -  | ■    | -   | ■   | ■   | 43                  |
|   |  | CPE14-M1CH-5L...   | -                     | ■    | 24                          | -            | -  | ■    | -   | -   | -   | -                   |
|   | <b>5/2-way double solenoid valve</b>                               |                    |                       |      |                             |              |    |      |     |     |     |                     |
|   |  | CPE14-M1BH-5J...   | ■                     | -    | 24                          | -            | -  | ■    | -   | ■   | ■   | 43                  |
|   |  | CPE14-M1CH-5J...   | -                     | ■    | 24                          | -            | -  | ■    | -   | -   | -   | -                   |
|   | <b>5/3-way solenoid valve, normally closed, mid-position valve</b> |                    |                       |      |                             |              |    |      |     |     |     |                     |
|   |  | CPE14-M1BH-5/3G... | ■                     | -    | 24                          | -            | -  | ■    | -   | ■   | ■   | 44                  |
| CPE14-M1CH-5/3G...  |  | -                  | ■                     | 24   | -                           | -            | ■  | -    | -   | -   | -   |                     |
| <b>5/3-way solenoid valve, normally open, mid-position valve</b>      |  |                    |                       |      |                             |              |    |      |     |     |     |                     |
|   | CPE14-M1BH-5/3B...   | ■                  | -                     | 24   | -                           | -            | ■  | -    | ■   | ■   | 44  |                     |
|   | CPE14-M1CH-5/3B...   | -                  | ■                     | 24   | -                           | -            | ■  | -    | -   | -   | -   |                     |
| <b>5/3-way solenoid valve, normally exhausted, mid-position valve</b> |  |                    |                       |      |                             |              |    |      |     |     |     |                     |
|   | CPE14-M1BH-5/3E...   | ■                  | -                     | 24   | -                           | -            | ■  | -    | ■   | ■   | 44  |                     |
|   | CPE14-M1CH-5/3E...   | -                  | ■                     | 24   | -                           | -            | ■  | -    | -   | -   | -   |                     |









## Product range overview – Width 18 mm

| Width   | Circuit symbol  | Type  | Operating voltage  |                   | Working port |     |      | → Page/<br>Internet |    |  |
|---|---|---|--|-------------------|--------------|-----|------|---------------------|----|--|
|   |   |   | [V DC]   | [V AC]            | G1/4         | QS8 | QS10 |                     |    |  |
| 18 mm   |    | <b>3/2-way single solenoid valve, normally closed</b>                             |  |                   |              |     |      |                     |    |  |
|   |   | CPE18-M1H-3GL...  | 24   | –                 | ■            | ■   | ■    | 59                  |    |  |
|   |   | CPE18-M2H-3GL...  | –  | 110               | ■            | ■   | ■    |                     |    |  |
|   |   | CPE18-M3H-3GL...  | –  | 220               | ■            | ■   | ■    |                     |    |  |
|   |   | CPE18-P1-3GL...1/4  | 12 <sup>1)</sup>   | 110 <sup>1)</sup> | ■            | –   | –    |                     | 66 |  |
|   |   |   | 24 <sup>1)</sup>   | 230 <sup>1)</sup> | ■            | –   | –    |                     |    |  |
|   |   |  | <b>3/2-way single solenoid valve, normally open</b>                |                   |              |     |      |                     |    |  |
|   |   |   | CPE18-M1H-3OL...   | 24                | –            | ■   | ■    | ■                   | 59 |  |
|   | CPE18-M2H-3OL...  |   | –  | 110               | ■            | ■   | ■    |                     |    |  |
|   | CPE18-M3H-3OL...  |   | –  | 220               | ■            | ■   | ■    |                     |    |  |
|   | CPE18-P1-3OL...1/4  |   | 12 <sup>1)</sup>   | 110 <sup>1)</sup> | ■            | –   | –    | 66                  |    |  |
|   |   |   | 24 <sup>1)</sup>   | 230 <sup>1)</sup> | ■            | –   | –    |                     |    |  |
|   |    |   | <b>5/2-way single solenoid valve</b>                               |                   |              |     |      |                     |    |  |
|   |   |   | CPE18-M1H-5L...  | 24                | –            | ■   | ■    | ■                   | 60 |  |
|   |   | CPE18-M2H-5L...   | –  | 110               | ■            | ■   | ■    |                     |    |  |
|   |   | CPE18-M3H-5L...   | –  | 220               | ■            | ■   | ■    |                     |    |  |
|   |   | CPE18-P1-5L...1/4   | 12 <sup>1)</sup>   | 110 <sup>1)</sup> | ■            | –   | –    | 66                  |    |  |
|   |   |   | 24 <sup>1)</sup>   | 230 <sup>1)</sup> | ■            | –   | –    |                     |    |  |
|   |   |  | <b>5/2-way double solenoid valve</b>                               |                   |              |     |      |                     |    |  |
|   |   |   | CPE18-M1H-5J...  | 24                | –            | ■   | ■    | ■                   | 60 |  |
|   | CPE18-M2H-5J...   |   | –  | 110               | ■            | ■   | ■    |                     |    |  |
|   | CPE18-M3H-5J...   |   | –  | 220               | ■            | ■   | ■    |                     |    |  |
|   | CPE18-P1-5J...1/4   |   | 12 <sup>1)</sup>   | 110 <sup>1)</sup> | ■            | –   | –    | 66                  |    |  |
|   |   |   | 24 <sup>1)</sup>   | 230 <sup>1)</sup> | ■            | –   | –    |                     |    |  |
|   |  |   | <b>5/3-way solenoid valve, normally closed, mid-position valve</b> |                   |              |     |      |                     |    |  |
|   |   |   | CPE18-M1H-5/3G...  | 24                | –            | ■   | ■    | ■                   | 61 |  |
|   |   | CPE18-M2H-5/3G...   | –  | 110               | ■            | ■   | ■    |                     |    |  |
|   |   | CPE18-M3H-5/3G...   | –  | 220               | ■            | ■   | ■    |                     |    |  |
| CPE18-P1-5/3G...1/4   |   | 12 <sup>1)</sup>  | 110 <sup>1)</sup>  | ■                 | –            | –   | 66   |                     |    |  |
|   |   | 24 <sup>1)</sup>  | 230 <sup>1)</sup>  | ■                 | –            | –   |      |                     |    |  |
|  |   | <b>5/3-way solenoid valve, normally open, mid-position valve</b>                  |  |                   |              |     |      |                     |    |  |
|   |   | CPE18-M1H-5/3B...   | 24   | –                 | ■            | ■   | ■    | 61                  |    |  |
|   | CPE18-M2H-5/3B...   | –   | 110  | ■                 | ■            | ■   |      |                     |    |  |
|   | CPE18-M3H-5/3B...   | –   | 220  | ■                 | ■            | ■   |      |                     |    |  |
|   | CPE18-P1-5/3B...1/4   | 12 <sup>1)</sup>  | 110 <sup>1)</sup>  | ■                 | –            | –   | 66   |                     |    |  |
|   |   | 24 <sup>1)</sup>  | 230 <sup>1)</sup>  | ■                 | –            | –   |      |                     |    |  |
|   |  | <b>5/3-way solenoid valve, normally exhausted, mid-position valve</b>             |  |                   |              |     |      |                     |    |  |
|   |   | CPE18-M1H-5/3E...   | 24   | –                 | ■            | ■   | ■    | 61                  |    |  |
| CPE18-M2H-5/3E...   |   | –   | 110  | ■                 | ■            | ■   |      |                     |    |  |
| CPE18-M3H-5/3E...   |   | –   | 220  | ■                 | ■            | ■   |      |                     |    |  |
| CPE18-P1-5/3E...1/4   |   | 12 <sup>1)</sup>  | 110 <sup>1)</sup>  | ■                 | –            | –   | 66   |                     |    |  |
|   |   | 24 <sup>1)</sup>  | 230 <sup>1)</sup>  | ■                 | –            | –   |      |                     |    |  |

1) Operating voltage dependent on separately ordered pilot valve

Product range overview – Width 24 mm

| Width   | Circuit symbol   | Type   | Operating voltage |        | Working port |      |      | → Page/<br>Internet |
|---|--|--|-------------------|--------|--------------|------|------|---------------------|
|   |  |  | [V DC]            | [V AC] | G3/8         | QS10 | QS12 |                     |
| 24 mm   |   | <b>3/2-way single solenoid valve, normally closed</b>              |                   |        |              |      |      |                     |
|   |  | CPE24-M1H-3GL...   | 24                | –      | ■            | ■    | ■    | 81                  |
|   |  | CPE24-M2H-3GL...   | –                 | 110    | ■            | ■    | ■    |                     |
|   | CPE24-M3H-3GL...   | –  | 220               | ■      | ■            | ■    |      |                     |
|   |   | <b>3/2-way single solenoid valve, normally open</b>                |                   |        |              |      |      |                     |
|   |  | CPE24-M1H-3OL...   | 24                | –      | ■            | ■    | ■    | 81                  |
|   |  | CPE24-M2H-3OL...   | –                 | 110    | ■            | ■    | ■    |                     |
|   | CPE24-M3H-3OL...   | –  | 220               | ■      | ■            | ■    |      |                     |
|   |   | <b>5/2-way single solenoid valve</b>                               |                   |        |              |      |      |                     |
|   |  | CPE24-M1H-5L...  | 24                | –      | ■            | ■    | ■    | 82                  |
|   |  | CPE24-M2H-5L...  | –                 | 110    | ■            | ■    | ■    |                     |
|   | CPE24-M3H-5L...  | –  | 220               | ■      | ■            | ■    |      |                     |
|   |   | <b>5/2-way double solenoid valve</b>                               |                   |        |              |      |      |                     |
|   |  | CPE24-M1H-5J...  | 24                | –      | ■            | ■    | ■    | 82                  |
|   |  | CPE24-M2H-5J...  | –                 | 110    | ■            | ■    | ■    |                     |
|   | CPE24-M3H-5J...  | –  | 220               | ■      | ■            | ■    |      |                     |
|   |   | <b>5/3-way solenoid valve, normally closed, mid-position valve</b> |                   |        |              |      |      |                     |
|   |  | CPE24-M1H-5/3G...  | 24                | –      | ■            | ■    | ■    | 83                  |
|   |  | CPE24-M2H-5/3G...  | –                 | 110    | ■            | ■    | ■    |                     |
|   | CPE24-M3H-5/3G...  | –  | 220               | ■      | ■            | ■    |      |                     |
|   |  | <b>5/3-way solenoid valve, normally open, mid-position valve</b>   |                   |        |              |      |      |                     |
|   |  | CPE24-M1H-5/3B...  | 24                | –      | ■            | ■    | ■    | 83                  |
|   |  | CPE24-M2H-5/3B...  | –                 | 110    | ■            | ■    | ■    |                     |
|   | CPE24-M3H-5/3B...  | –  | 220               | ■      | ■            | ■    |      |                     |
|  | <b>5/3-way solenoid valve, normally exhausted, mid-position valve</b>              |  |                   |        |              |      |      |                     |
|   | CPE24-M1H-5/3E...  | 24   | –                 | ■      | ■            | ■    | 83   |                     |
|   | CPE24-M2H-5/3E...  | –  | 110               | ■      | ■            | ■    |      |                     |
| CPE24-M3H-5/3E...   | –  | 220  | ■                 | ■      | ■            |      |      |                     |

Product range overview – Functions

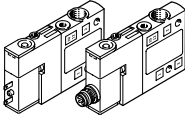
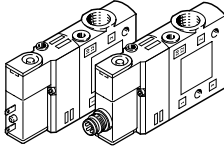
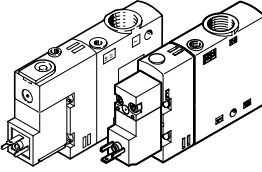
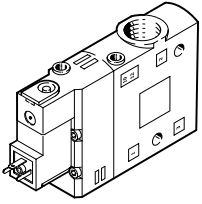
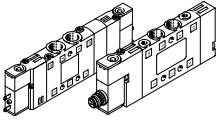
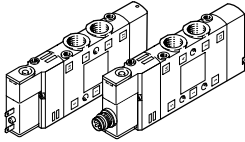
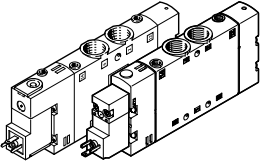
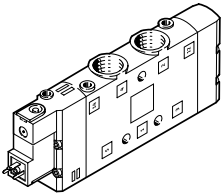
| 3/2-way valves                            |       |   |   |   |   |
|---|-------|--|--|---|--|
| Type                                      |       | CPE10  | CPE14  | CPE18   | CPE24  |
| Width                                     |       | 10 mm  | 14 mm  | 18 mm   | 24 mm  |
| <b>Standard nominal flow rate [l/min]</b> |       |  |  |   |  |
| Thread                                    | M5    | 190  | –  | –   | –  |
|   | M7    | 400  | –  | –   | –  |
|   | G1/8  | –  | 900  | –   | –  |
|   | G1/4  | –  | –  | 1300  | –  |
|   | G3/8  | –  | –  | –   | 2500   |
| Push-in connector                         | QS-4  | 190  | –  | –   | –  |
|   | QS-6  | 300  | 510  | –   | –  |
|   | QS-8  | –  | 810  | 850   | –  |
|   | QS-10 | –  | –  | 1000  | 1250   |
|   | QS-12 | –  | –  | –   | 1650   |
| <b>5/2-way valves, single solenoid</b>    |       |  |  |   |  |
|   |       |  |  |  |  |
| Type                                      |       | CPE10  | CPE14  | CPE18   | CPE24  |
| Width                                     |       | 10 mm  | 14 mm  | 18 mm   | 24 mm  |
| <b>Standard nominal flow rate [l/min]</b> |       |  |  |   |  |
| Thread                                    | M5    | 180  | –  | –   | –  |
|   | M7    | 350  | –  | –   | –  |
|   | G1/8  | –  | 800  | –   | –  |
|   | G1/4  | –  | –  | 1300  | –  |
|   | G3/8  | –  | –  | –   | 2900   |
| Push-in connector                         | QS-4  | 180  | –  | –   | –  |
|   | QS-6  | 320  | 400  | –   | –  |
|   | QS-8  | –  | 680  | 850   | –  |
|   | QS-10 | –  | –  | 1000  | 1250   |
|   | QS-12 | –  | –  | –   | 1650   |
| <b>Operating voltage</b>                  |       |  |  |   |  |
| 12 V DC                                   |       | –  | –  | ■   | –  |
| 24 V DC/AC                                |       | ■/–  | ■/–  | ■/■   | ■/–  |
| 110 V AC                                  |       | –  | –  | ■   | ■  |
| 230 V AC                                  |       | –  | –  | ■   | ■  |
| Datasheet → Page                          |       | 20   | 35   | 53  | 75   |

Product range overview – Functions

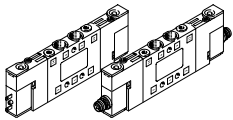
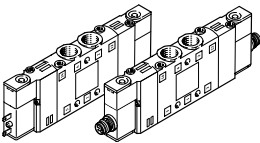
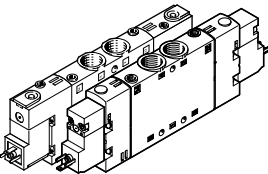
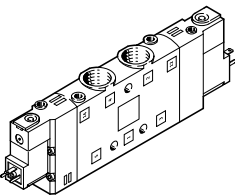
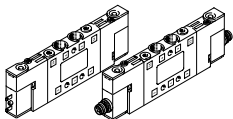
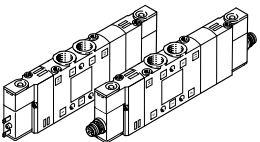
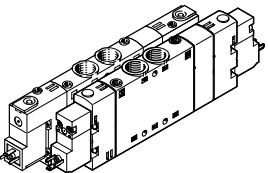
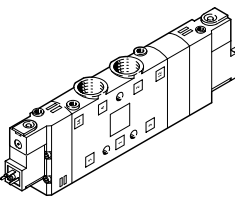
|   |       |  |  |   |  |
|---|-------|--|--|---|--|
| <b>5/2-way valves, double solenoid</b>    |       |   |   |   |   |
| Type                                      |       | CPE10  | CPE14  | CPE18   | CPE24  |
| Width                                     |       | 10 mm  | 14 mm  | 18 mm   | 24 mm  |
| <b>Standard nominal flow rate [l/min]</b> |       |  |  |   |  |
| Thread                                    | M5    | 180  | –  | –   | –  |
|   | M7    | 350  | –  | –   | –  |
|   | G1/8  | –  | 800  | –   | –  |
|   | G1/4  | –  | –  | 1300  | –  |
|   | G3/8  | –  | –  | –   | 3200   |
| Push-in connector                         | QS-4  | 180  | –  | –   | –  |
|   | QS-6  | 320  | 400  | –   | –  |
|   | QS-8  | –  | 680  | 850   | –  |
|   | QS-10 | –  | –  | 1000  | 1250   |
|   | QS-12 | –  | –  | –   | 1650   |
| <b>5/3-way valves</b>                     |       |  |  |   |  |
|   |       |  |  |  |  |
| Type                                      |       | CPE10  | CPE14  | CPE18   | CPE24  |
| Width                                     |       | 10 mm  | 14 mm  | 18 mm   | 24 mm  |
| <b>Standard nominal flow rate [l/min]</b> |       |  |  |   |  |
| Thread                                    | M5    | 180  | –  | –   | –  |
|   | M7    | 250 ... 350  | –  | –   | –  |
|   | G1/8  | –  | 700 ... 750  | –   | –  |
|   | G1/4  | –  | –  | 1200 ... 1450   | –  |
|   | G3/8  | –  | –  | –   | 2600 ... 3000  |
| Push-in connector                         | QS-4  | 180  | –  | –   | –  |
|   | QS-6  | 250 ... 300  | 370 ... 410  | –   | –  |
|   | QS-8  | –  | 570 ... 720  | 780 ... 850   | –  |
|   | QS-10 | –  | –  | 1000 ... 1050   | 1250   |
|   | QS-12 | –  | –  | –   | 1600 ... 1650  |
| <b>Operating voltage</b>                  |       |  |  |   |  |
| 12 V DC                                   |       | –  | –  | ■   | –  |
| 24 V DC/AC                                |       | ■/–  | ■/–  | ■/■   | ■/–  |
| 110 V AC                                  |       | –  | –  | ■   | ■  |
| 230 V AC                                  |       | –  | –  | ■   | ■  |
| Datasheet → Page                          |       | 20   | 35   | 53  | 75   |

## Peripherals overview

## Individual valve – CPE10 and CPE14

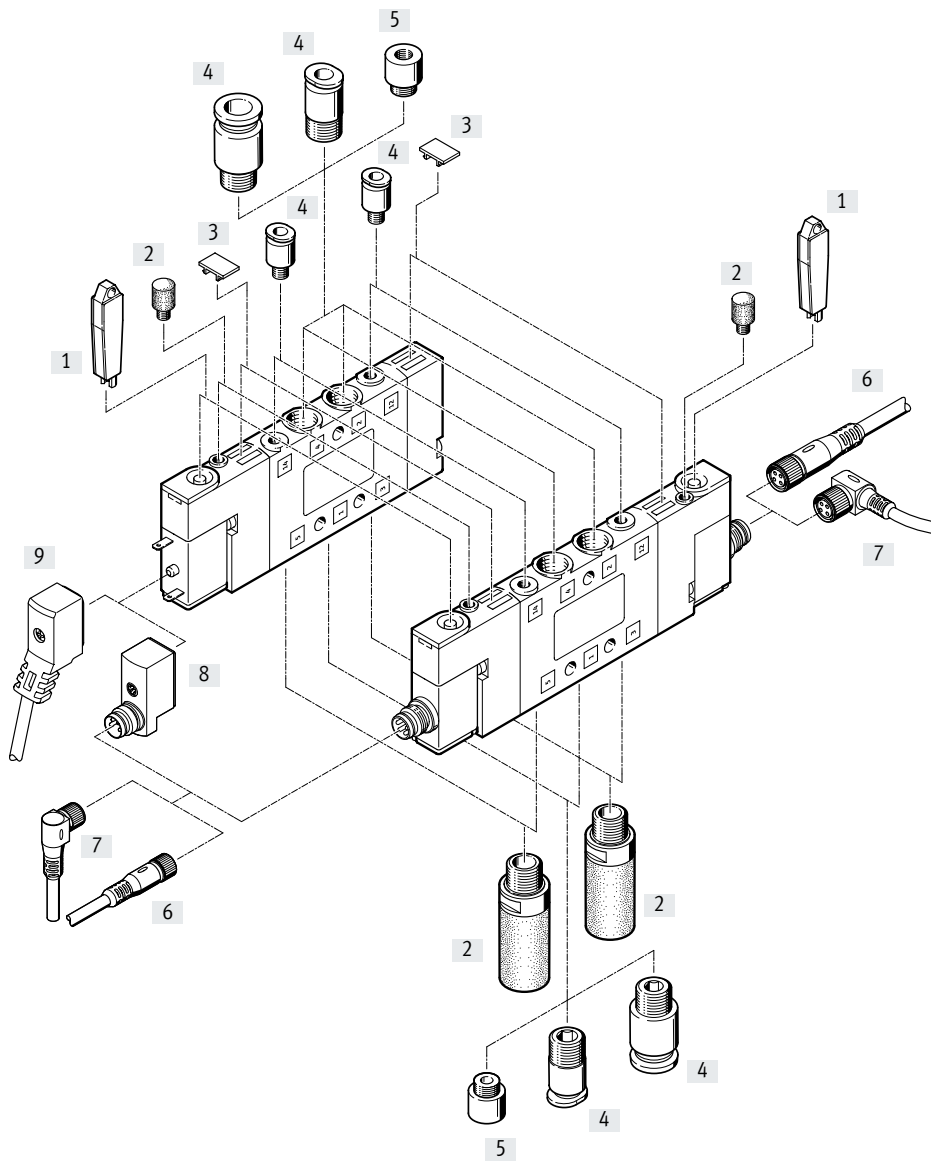

## Accessories – Individual valve

|                          | Type          | Description  | CPE10 | CPE14 | → Page/Internet |
|--------------------------|---------------|--|-------|-------|-----------------|
| [1] Manual override tool | AHB...        | –  | ■     | ■     | 86              |
| [2] Silencer             | U... or UC... | For port 3, 5, 82 or 84  | ■     | ■     | 86              |
| [3] Inscription label    | IBS-6x10      | –  | ■     | ■     | 86              |
| [4] Push-in fittings     | QS...         | For tubing   | ■     | ■     | qs              |
| [5] M7 to M5 reducer     | –             | Included in the scope of delivery  | ■     | –     | –               |
| [6] Connecting cable     | NEBU-M8G...   | Socket M8x1, straight  | ■     | ■     | 85              |
| [7] Connecting cable     | NEBU-M8W...   | Socket M8x1, angled  | ■     | ■     | 85              |
| [8] Adapter              | VAVE-C8...    | Plug pattern ZC to M8, with signal status indication   | ■     | ■     | 85              |
| [9] Connecting cable     | NEBV-Z4...    | Plug pattern ZC with holding current reduction, protective circuit, signal status indication | ■     | ■     | 85              |
| – 2 to 1 distributor     | NEDY...       | 2x socket plug pattern ZC on 1x plug, M8x1 or M12x1  | ■     | ■     | 85              |

## Peripherals overview

### Individual valve – CPE18 and CPE24

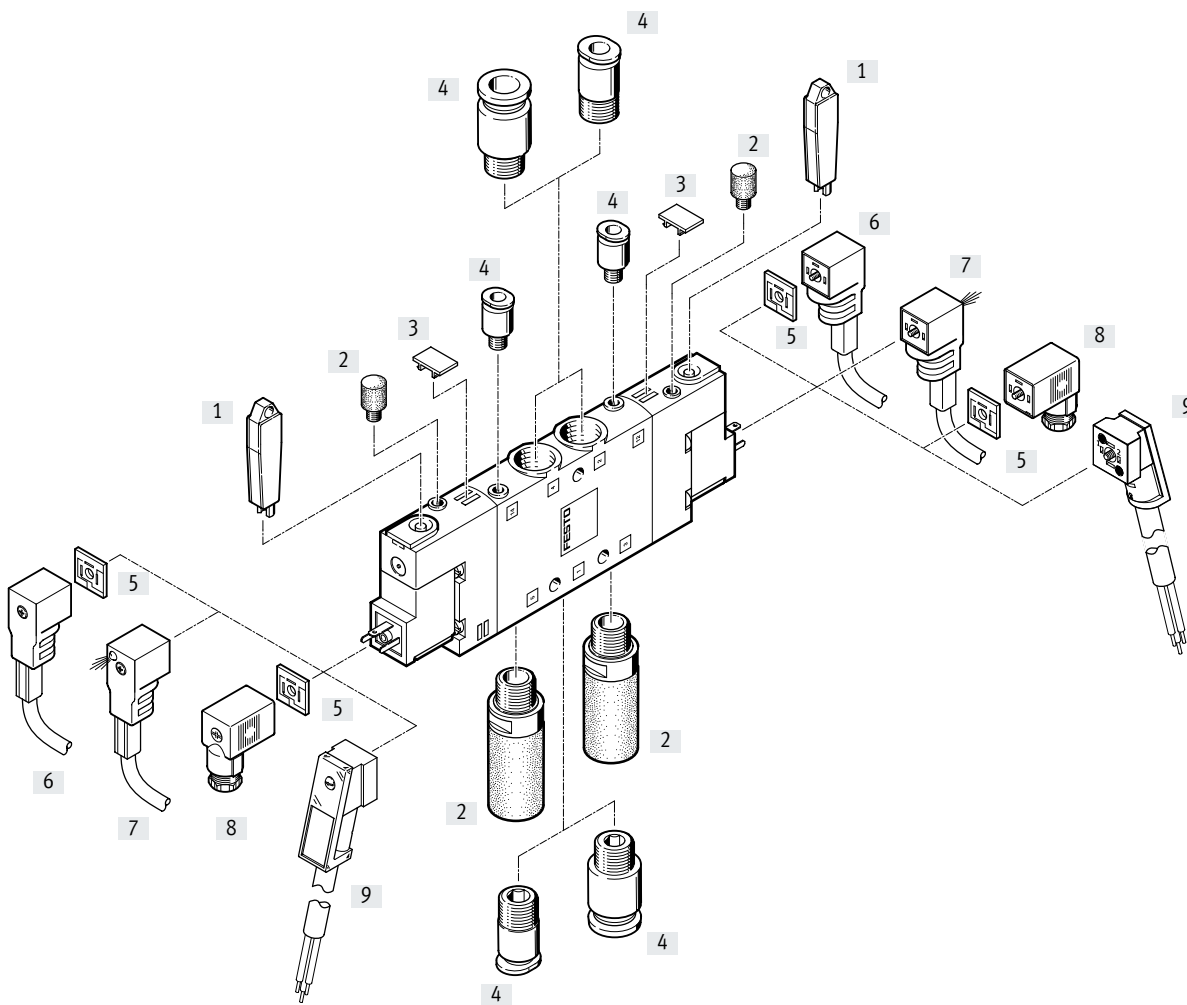

| Accessories – Individual valve |                        | Type          | Description   | CPE18 | CPE24 | → Page/Internet |
|--------------------------------|------------------------|---------------|---|-------|-------|-----------------|
| [1]                            | Manual override tool   | AHB...        | –   | ■     | ■     | 86              |
| [2]                            | Silencer               | U... or UC... | For port 3, 5, 82 or 84   | ■     | ■     | 86              |
| [3]                            | Inscription label      | IBS-6x10      | –   | ■     | ■     | 86              |
| [4]                            | Push-in fittings       | QS...         | For tubing  | ■     | ■     | qs              |
| [5]                            | Illuminating seal      | MEB...LD      | For 0 ... 230 V AC  | ■     | ■     | 86              |
| [6]                            | Plug socket with cable | KMEB-1...     | Cable sheath PVC, up to 240 V, without signal status indication | ■     | ■     | 86              |
| [7]                            | Plug socket with cable | KMEB-1...     | Cable sheath PVC, 24 V DC, with signal status indication        | ■     | ■     | 86              |
| [8]                            | Plug socket            | MSSD-EB...    | Without signal status indication                                | ■     | ■     | 86              |
| [9]                            | Plug socket with cable | KMEB-2...     | Cable sheath PUR  | ■     | ■     | 86              |

## System overview

### Fixed-grid manifold assembly

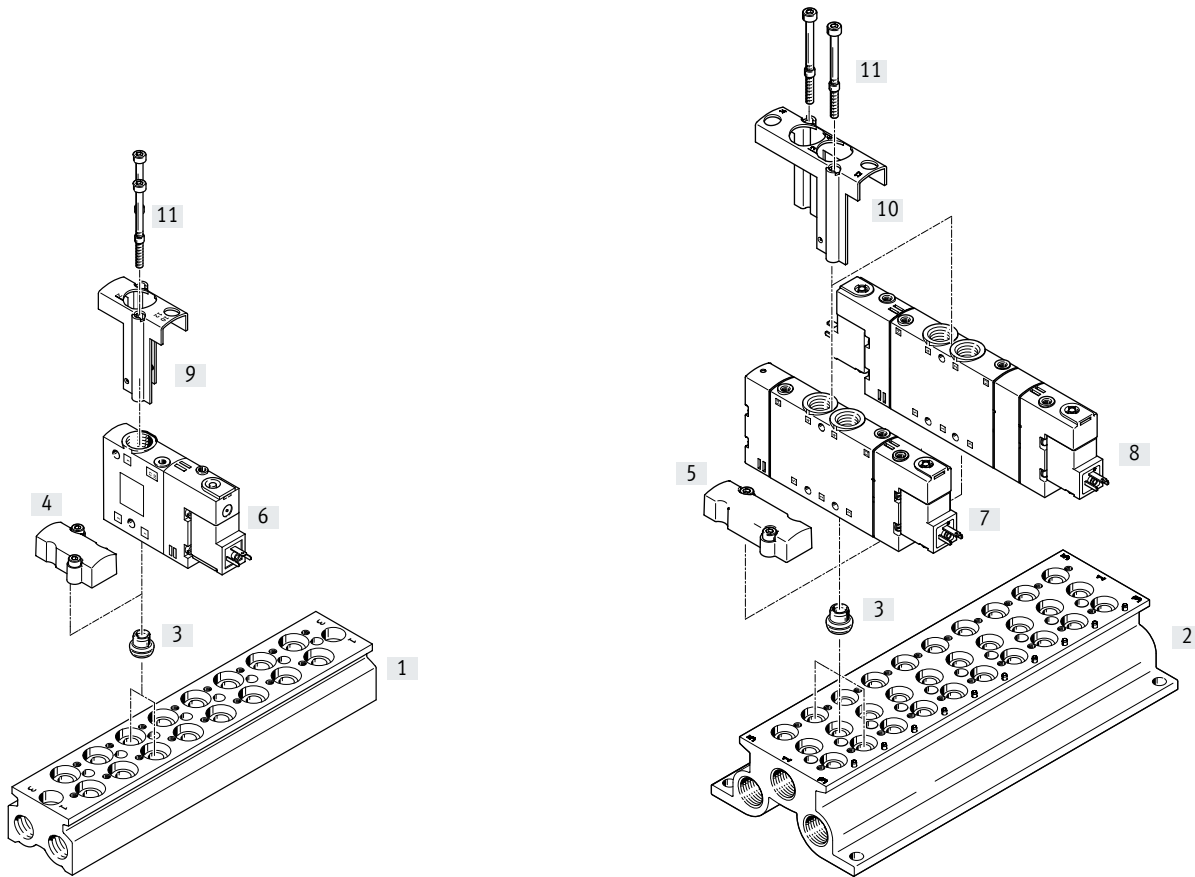

#### Example of manifold assembly – CPE18

|                        | Type               | Description   | → Page/Internet |       |       |
|------------------------|--------------------|---|-----------------|-------|-------|
|                        |                    |   | CPE10           | CPE14 | CPE18 |
| [1] Manifold block     | CPE18-3/2-PRS...   | For 3/2-way valves  | 31              | 48    | 70    |
| [2] Manifold block     | CPE18-PRS...       | For 5/2-way and 5/3-way valves                              | 29              | 46    | 68    |
| [3] Seal               | CPV18-VI-P.1/4-150 | –   | 29              | 46    | 70    |
| [4] Cover plate        | CPE18-RP3          | For fitting on vacant positions for 3/2-way valves          | 31              | 48    | 70    |
| [5] Cover plate        | CPE18-RP           | For fitting on vacant positions for 5/2- and 5/3-way valves | 29              | 46    | 68    |
| [6] 3/2-way valve      | CPE18...           | –   | 26              | 43    | 59    |
| [7] 5/2-way valve      | CPE18...           | –   | 26              | 43    | 60    |
| [8] 5/3-way valve      | CPE18...           | –   | 27              | 44    | 61    |
| [9] Retaining bracket  | CPE18-H3-50        | Retaining bracket for 3/2-way valve                         | 31              | 48    | 70    |
| [10] Retaining bracket | CPE18-H5-50        | Retaining bracket for 5/2- and 5/3-way valve                | 29              | 46    | 68    |
| [11] Screw             | M4X65-8.8-VS-100   | –   | 29              | 46    | 70    |

## Peripherals overview

### Accessories – Fixed-grid manifold assembly CPE10 and CPE14

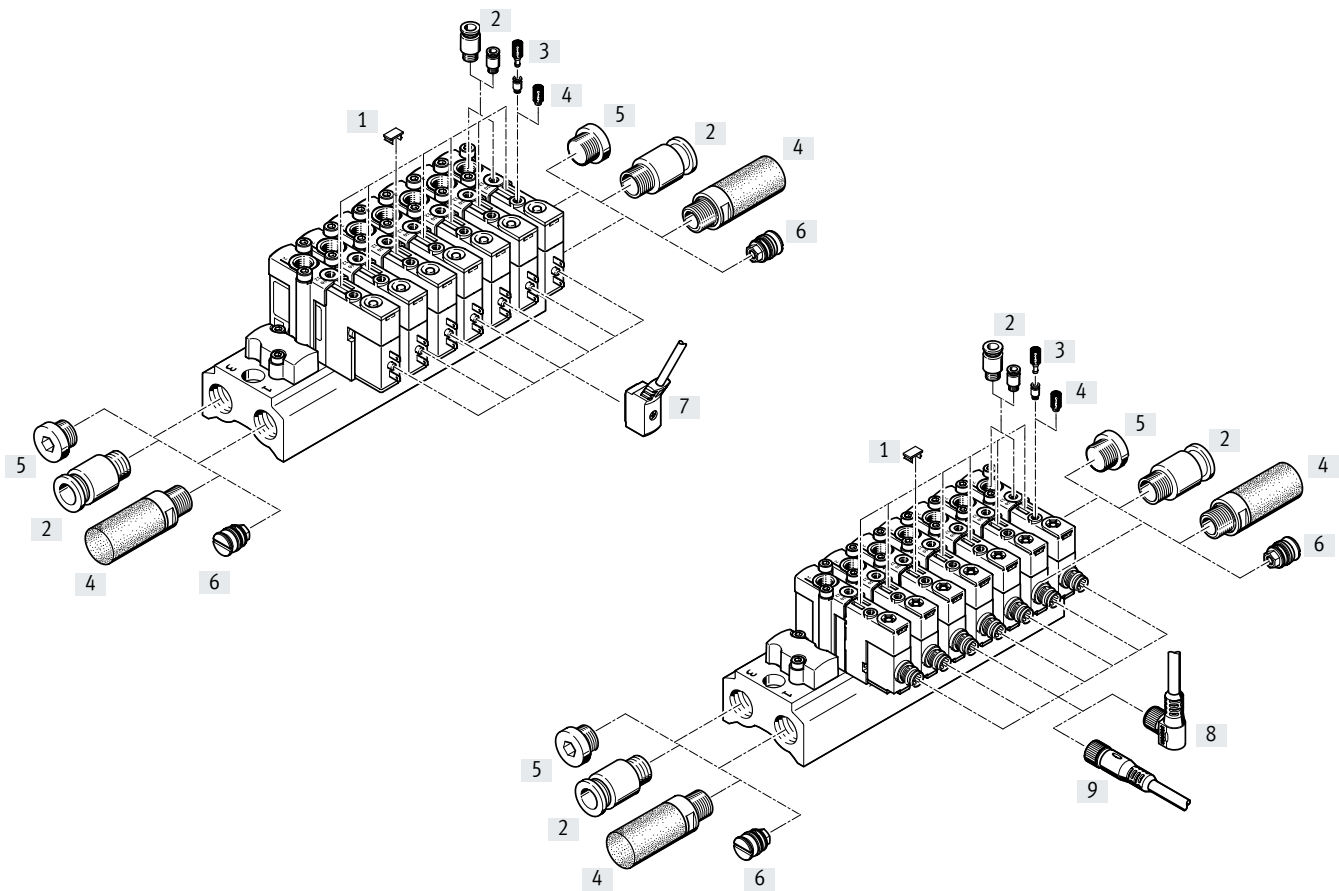

| Accessories |                    | Type             | Description  | CPE10 | CPE14 | → Page/Internet |
|-------------|--------------------|------------------|--|-------|-------|-----------------|
| [1]         | Inscription label  | IBS-6x10         | –  | ■     | ■     | 86              |
| [2]         | Push-in fittings   | QS...            | For tubing   | ■     | ■     | qs              |
| [3]         | M7 to M5 reducer   | –                | Included in the scope of delivery  | ■     | –     | –               |
| [4]         | Silencer           | U... or UC...    | For port 3, 5, 82 or 84  | ■     | ■     | 86              |
| [5]         | Blanking plug      | B...             | –  | ■     | ■     | 86              |
| [6]         | Separator          | VABD..., PRSV... | For fitting on the manifold block  | ■     | ■     | 86              |
| [7]         | Connecting cable   | NEBV-Z4...       | Plug pattern ZC with holding current reduction, protective circuit, signal status indication | ■     | ■     | 85              |
| [8]         | Connecting cable   | NEBU-M8W...      | Socket M8x1, angled  | ■     | ■     | 85              |
| [9]         | Connecting cable   | NEBU-M8G...      | Socket M8x1, straight  | ■     | ■     | 85              |
| –           | 2 to 1 distributor | NEDY...          | 2x socket plug pattern ZC on 1x plug, M8x1 or M12x1  | ■     | ■     | 85              |



## Peripherals overview

## Accessories – Fixed-grid manifold assembly CPE18

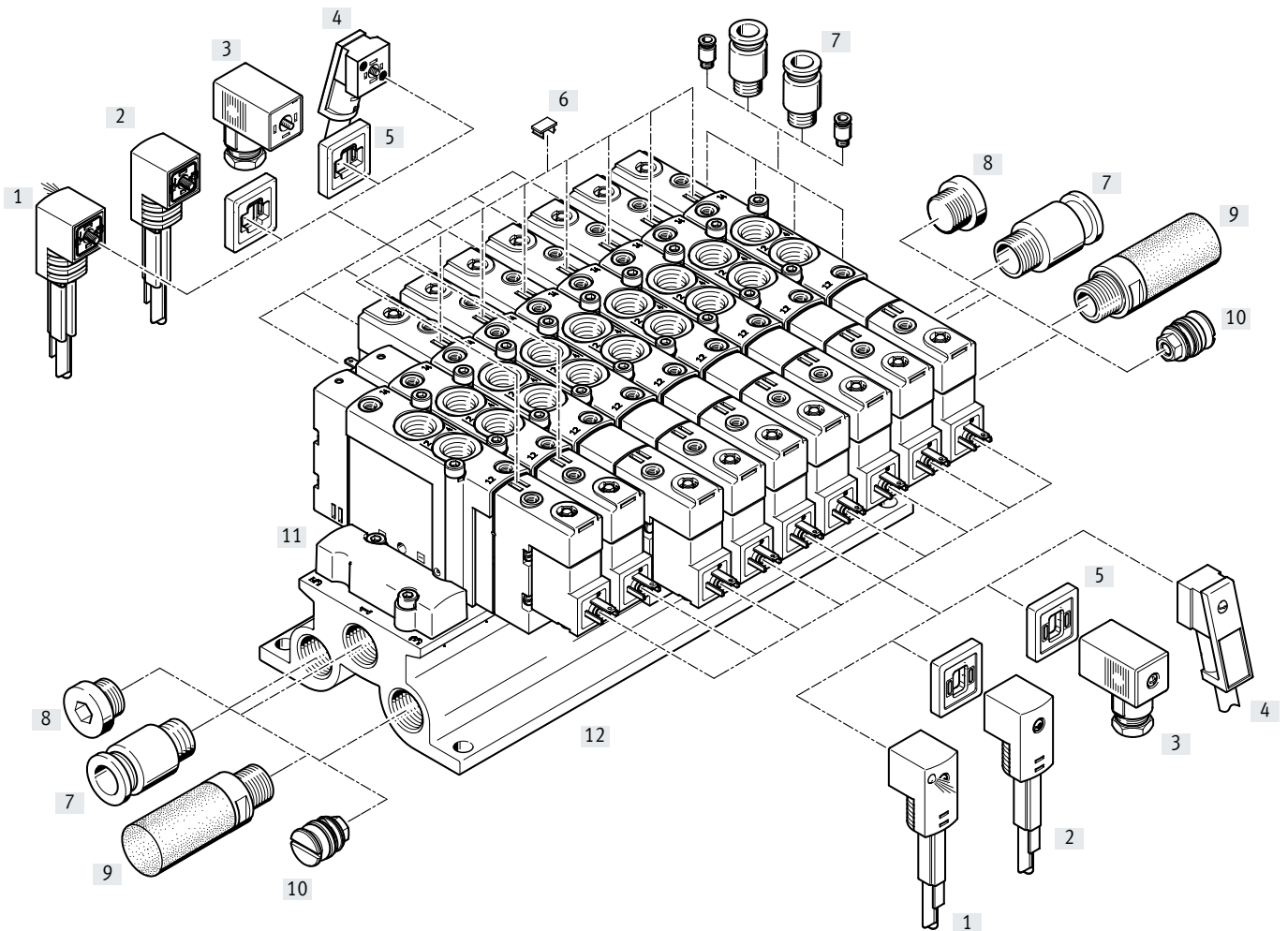

## Accessories – Mounting on manifold block

|      | Type             | Description  | → Page/Internet |
|------|------------------|--|-----------------|
| [1]  | KMEB-1...        | Cable sheath PVC, 24 V DC, with signal status indication     | 86              |
| [2]  | KMEB-1...        | Cable sheath PVC, to 240 V, without signal status indication | 86              |
| [3]  | MSSD-EB...       | Without signal status indication                             | 86              |
| [4]  | KMEB-2...        | Cable sheath PUR   | 86              |
| [5]  | MEB-LD...        | For 12 ... 24 V DC and 0 ... 230 V AC                        | 86              |
| [6]  | IBS-6x10         | –  | 86              |
| [7]  | QS...            | For tubing   | qs              |
| [8]  | B...             | –  | 86              |
| [9]  | U... or UC...    | For mounting in exhaust ports                                | 86              |
| [10] | VABD..., PRSV... | For fitting on the manifold block                            | 86              |
| [11] | CPE18-RP         | For fitting on vacant positions for 5/2- and 5/3-way valves  | 68              |
|      | CPE18-RP3        | For fitting on vacant positions for 3/2-way valves           | 70              |
| [12] | CPE18-PRS...     | For 5/2-way and 5/3-way valves                               | 68              |
|      | CPE18-3/2-PRS... | For 3/2-way valves   | 70              |

## System overview

### Manifold assembly with modular manifold blocks

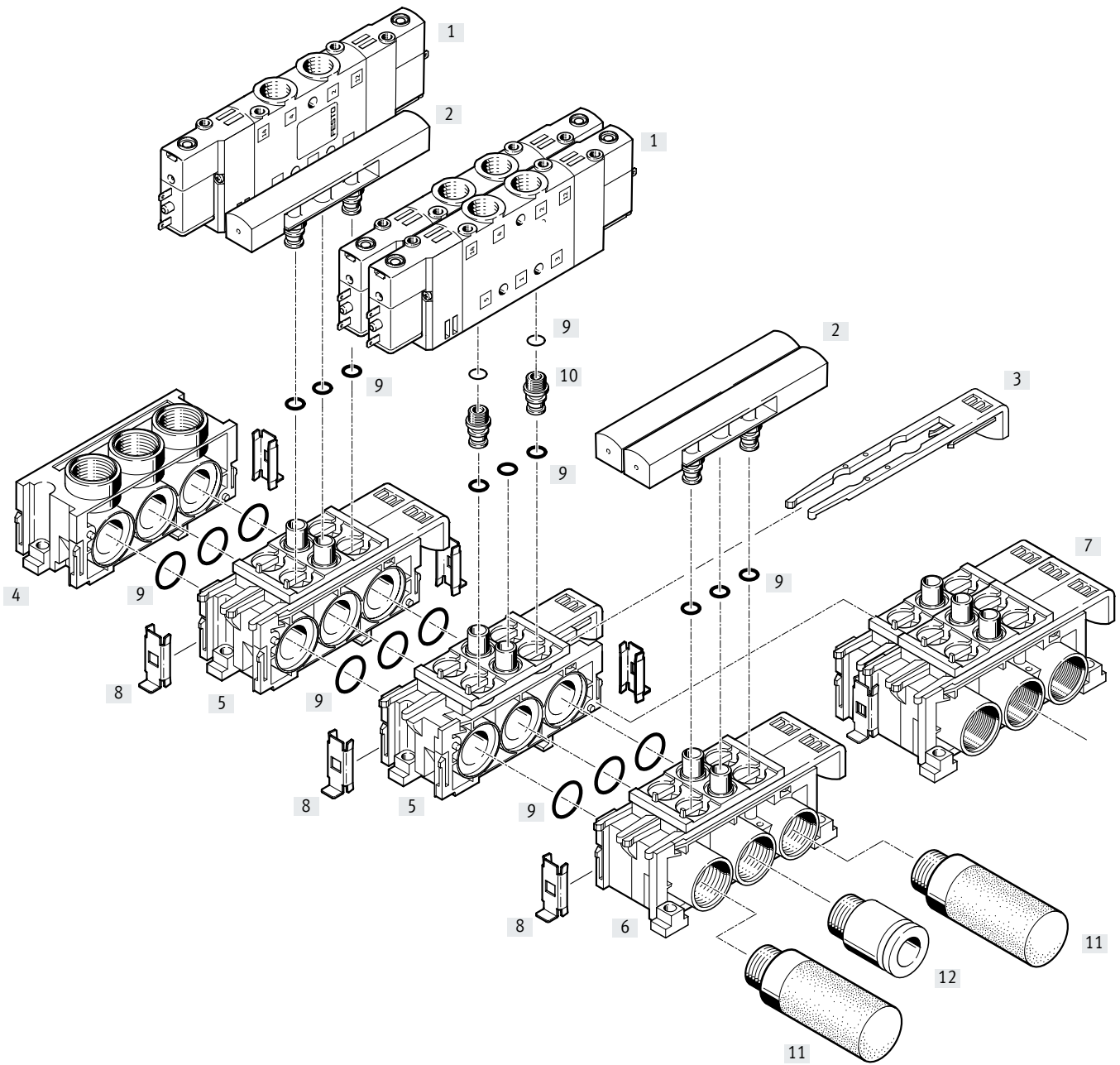

#### Accessories – Manifold assembly

|      | Type                 | Description   | → Page/Internet                   |
|------|----------------------|---------------|-----------------------------------|
| [1]  | Solenoid valve       | CPE...        | –                                 |
| [2]  | Cover plate          | CPE...-RP     | For sealing vacant positions      |
| [3]  | Spool                | –             | For mounting the valve            |
| [4]  | End plate            | CPE...-PRS-EP | –                                 |
| [5]  | Extension block      | CPE...-PRSE-2 | For 2 valves                      |
| [6]  | Manifold block       | CPE...-PRSG-2 | For 2 valves                      |
| [7]  | Manifold block       | CPE...-PRSG-3 | For 3 valves                      |
| [8]  | Connecting component | –             | For connecting the blocks         |
| [9]  | Seal                 | –             | Included in the scope of delivery |
| [10] | Fitting              | –             | Included in the scope of delivery |
| [11] | Silencer             | U or UC       | –                                 |
| [12] | Push-in fitting      | QS...         | For tubing                        |

## Type codes

| 001 Series                    |   |
|-------------------------------|---|
| CPE                           | Solenoid valve, Compact Performance     |
| 002 Width                     |   |
| 10                            | 10 mm                                   |
| 003 Nominal operating voltage |   |
| M1                            | 24 V DC                                 |
| 004 Electrical connection     |   |
| BH                            | Plug pattern ZC                         |
| CH                            | Plug M8x1                               |
| 005 Valve function            |   |
| 5L                            | 5/2-way valve, monostable               |
| 5J                            | 5/2-way valve, bistable                 |
| 3GL                           | 3/2-way valve, normally closed          |
| 3OL                           | 3/2-way valve, normally open            |
| 5/3G                          | 5/3-way valve, mid-position closed      |
| 5/3E                          | 5/3-way valve, mid-position exhausted   |
| 5/3B                          | 5/3-way valve, mid-position pressurised |



| 006 Pilot air            |                        |
|--------------------------|------------------------|
|                          | Internal               |
| S                        | External               |
| 007 Pneumatic connection |                        |
| M5                       | M5                     |
| M7                       | M7                     |
| QS-4                     | Push-in connector 4 mm |
| QS-6                     | Push-in connector 6 mm |
| 008 Generation           |                        |
|                          | None                   |
| B                        | Series B               |

## Datasheet

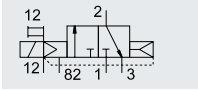
Function  
 3/2G, 3/2O,  
 5/2-way single solenoid  
 5/2-way double pilot valve  
 5/3G, 5/3B, 5/3E



e.g. 3/2-way valve with external pilot air supply, normally closed

-  - Width 10 mm
-  - Flow rate  
180 ... 400 l/min
-  - Voltage  
24 V DC

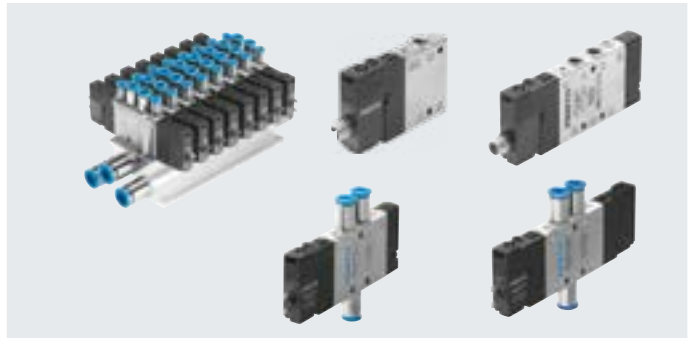

| General technical data                       |         |         | 3/2  |                 | 5/2    |   | 5/3             |                 |                 |     |
|--|---------|---------|--|-----------------|--------|---|-----------------|-----------------|-----------------|-----|
| Valve function                               |         |         | G <sup>1)</sup>  | O <sup>2)</sup> | -      | -   | G <sup>1)</sup> | B <sup>2)</sup> | E <sup>3)</sup> |     |
| Normal position                              |         |         | Monostable   |                 |        | Bistable                                  |                 | Monostable      |                 |     |
| Stable position                              |         |         | Yes  |                 |        | -   |                 | No              |                 |     |
| Pneumatic spring reset                       |         |         | No   |                 |        | -   |                 | Yes             |                 |     |
| Mechanical spring reset                      |         |         | Piston spool   |                 |        |   |                 |                 |                 |     |
| Design                                       |         |         | Soft   |                 |        |   |                 |                 |                 |     |
| Sealing principle                            |         |         | Positive overlap   |                 |        |   |                 |                 |                 |     |
| Overlap                                      |         |         | Electrical   |                 |        |   |                 |                 |                 |     |
| Actuation type                               |         |         | Piloted  |                 |        |   |                 |                 |                 |     |
| Type of control                              |         |         | Internal or external                                     |                 |        |   |                 |                 |                 |     |
| Pilot air supply                             |         |         | -  |                 |        | Reversible with external pilot air supply |                 |                 |                 |     |
| Flow direction                               |         |         | -  |                 |        | Can be throttled                          |                 |                 |                 |     |
| Exhaust function                             |         |         | Non-detenting, detenting via accessory                   |                 |        |   |                 |                 |                 |     |
| Manual override                              |         |         | Via through-holes  |                 |        |   |                 |                 |                 |     |
| Type of mounting                             |         |         | Any  |                 |        |   |                 |                 |                 |     |
| Mounting position                            |         |         | Threaded connection: M5, M7 QS connection: ø 4 or ø 6 mm |                 |        |   |                 |                 |                 |     |
| Pneumatic connection                         | 1, 2, 4 |         | Threaded connection: M7                                  |                 |        |   |                 |                 |                 |     |
|  | 3, 5    |         | Threaded connection: M3, QS connection: ø 3 mm           |                 |        |   |                 |                 |                 |     |
|  | 12, 14  |         | Threaded connection: M3                                  |                 |        |   |                 |                 |                 |     |
|  | 82, 84  |         |  |                 |        |   |                 |                 |                 |     |
| Nominal width                                |         | [mm]    | 4  |                 |        |   |                 |                 |                 |     |
| Standard nominal flow rate                   | M5      | [l/min] | 190  |                 | 180    |   |                 |                 |                 |     |
|  | M7      | [l/min] | 400  |                 | 350    |   | 300             |                 | 250             |     |
|  | QS4     | [l/min] | 190  |                 | 180    |   |                 |                 |                 |     |
|  | QS6     | [l/min] | 300  |                 | 350    |   | 320             |                 | 300             | 250 |
| Switching time                               | On/Off  | [ms]    | 1 4/14   |                 | 1 6/20 |   | -               |                 | 1 6/20          |     |
|  | Reverse | [ms]    | -  |                 | -      |   | 8               |                 | -               |     |
| Duty cycle                                   |         | [%]     | 100  |                 |        |   |                 |                 |                 |     |
| Width  |         | [mm]    | 10   |                 |        |   |                 |                 |                 |     |
| Corrosion resistance class CRC <sup>4)</sup> |         |         | 2  |                 |        |   |                 |                 |                 |     |

1) G = normally closed

2) O, B = normally open

3) E = normally exhausted

4) Corrosion resistance class CRC 2 to Festo standard FN 940070

Moderate corrosion stress. Indoor applications in which condensation can occur. External visible parts with primarily decorative surface requirements which are in direct contact with a normal industrial environment.

## Datasheet

| Operating and environmental conditions |                           |  |   |
|--|---------------------------|--|---|
| Valve function                         |                           | 3/2  | 5/2-way, single solenoid   5/2-way, double solenoid   5/3 |
| Operating medium                       |                           | Compressed air to ISO 8573-1:2010 [7:4:4]  |   |
| Pilot medium                           |                           | Compressed air to ISO 8573-1:2010 [7:4:4]  |   |
| Note on the operating/pilot medium     |                           | Lubricated operation possible (in which case lubricated operation will always be required) |   |
| Operating pressure                     | Internal pilot air supply | [MPa]  | 0.25 ... 0.8   0.3 ... 0.8                                |
|  |                           | [bar]  | 2.5 ... 8   3 ... 8                                       |
|  | External pilot air supply | [MPa]  | -0.09 ... 1   |
|  |                           | [bar]  | -0.9 ... 10   |
| Pilot pressure                         | [MPa]                     | 0.25 ... 0.8   0.3 ... 0.8   |   |
|  | [bar]                     | 2.5 ... 8   3 ... 8  |   |
| Ambient temperature                    | [°C]                      | -5 ... +50   |   |
| Temperature of medium                  | [°C]                      | -5 ... +50   |   |
| Certification for solenoid valves      |                           | c UL us - Recognized (OL) (not with M1CH-...)  |   |
| Maritime classification <sup>1)</sup>  |                           | See certificate  |   |

1) Additional information: [www.festo.com/sp](http://www.festo.com/sp) → Certificates.

| Electrical data                            |            |   |             |
|--|------------|---|-------------|
| Operating voltage                          | M1BH, M1CH | [V DC]  | 24 +10/-15% |
| Power consumption                          | M1BH, M1CH | [W]   | 1.28        |
| Degree of protection with plug socket      |            | IP65 to IEC 60529<br>M1CH: IP65/IP67 to IEC 60529 |             |
| Max. tightening torque of plug socket M8x1 | M1CH       | [Nm]  | 0.4         |

## Materials

Sectional view

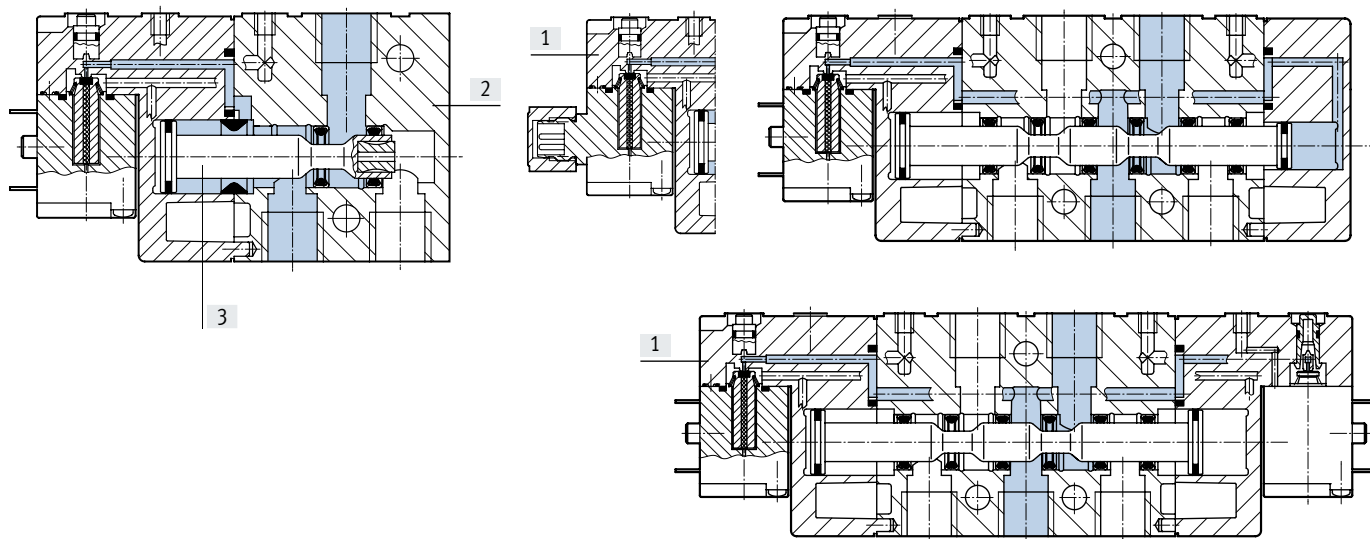

|                   |                    |
|-------------------|--------------------|
| [1] Cover         | PA                 |
| [2] Housing       | Die-cast aluminium |
| [3] Piston spool  | Steel              |
| - Seals           | NBR                |
| Note on materials | RoHS-compliant     |

Datasheet

Dimensions – 3/2-way valve

Download CAD data → [www.festo.com](http://www.festo.com)

CPE10-...-3...-M7

CPE10-...-3...-M5

CPE10-...-3...-QS-4

CPE10-...-3...-QS-6

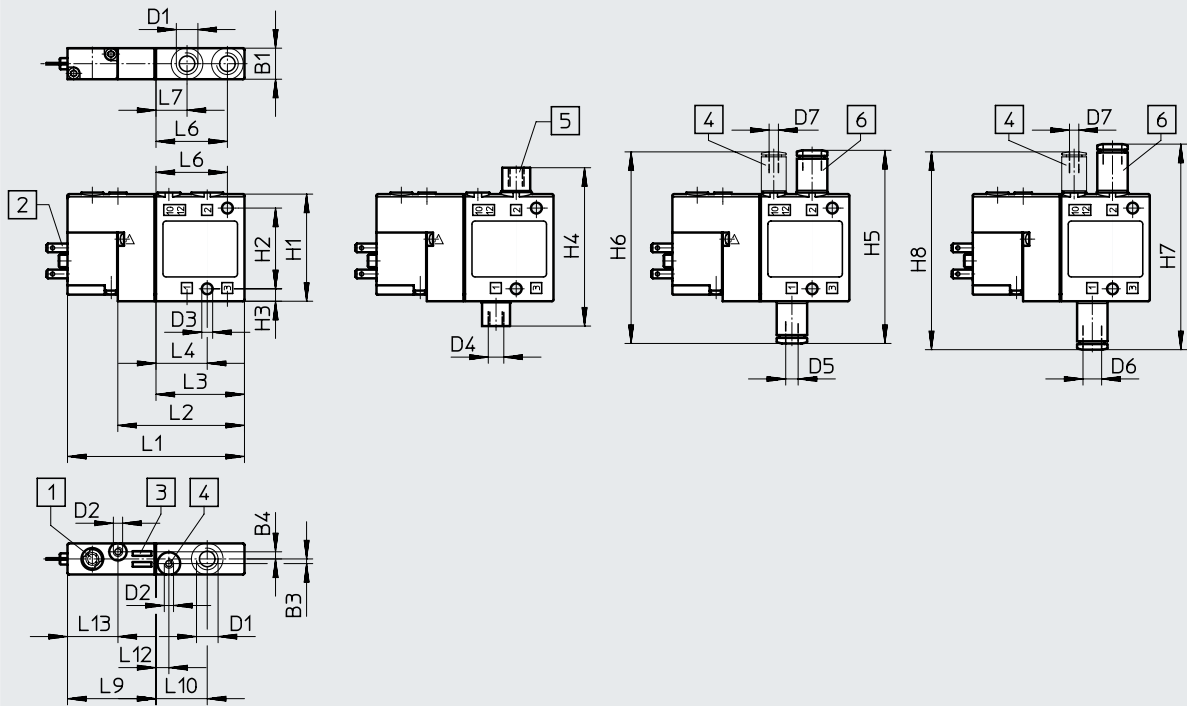

- [1] Manual override, push to reset
- [2] Plug pins, plug pattern ZC
- [3] Space for inscription labels
- [4] Port 10/12 for external pilot air
- [5] M7 to M5 reducer
- [6] QS push-in fitting

| Type            | B1 | B3  | B4  | D1 | D2 | D3 ø | D4 | D5 ø | D6 ø | D7 ø | H1 | H2 | H3 | H4 | H5   | H6   | H7   | H8   |
|-----------------|----|-----|-----|----|----|------|----|------|------|------|----|----|----|----|------|------|------|------|
| CPE10-M1BH-3... | 10 | 1.5 | 2.3 | M7 | M3 | 3.5  | M5 | 4    | 6    | 3    | 35 | 26 | 4  | 51 | 62.2 | 61.7 | 66.2 | 63.7 |

| Type            | L1 | L2   | L3   | L4   | L6 | L7 | L9   | L10  | L12 | L13  |
|-----------------|----|------|------|------|----|----|------|------|-----|------|
| CPE10-M1BH-3... | 57 | 40.8 | 28.5 | 16.5 | 23 | 10 | 28.5 | 16.5 | 4.2 | 16.3 |

Datasheet

Dimensions – 5/2-way single solenoid valve

Download CAD data → [www.festo.com](http://www.festo.com)

CPE10-...-5L...-M7

CPE10-...-5L...-M5

CPE10-...-5L...-QS-4

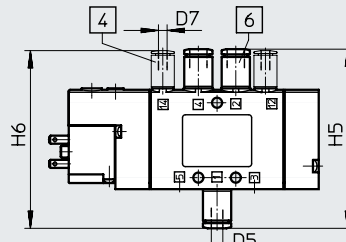
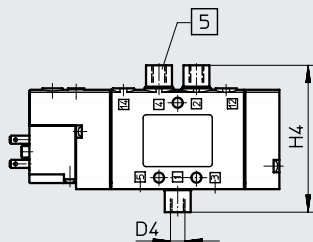
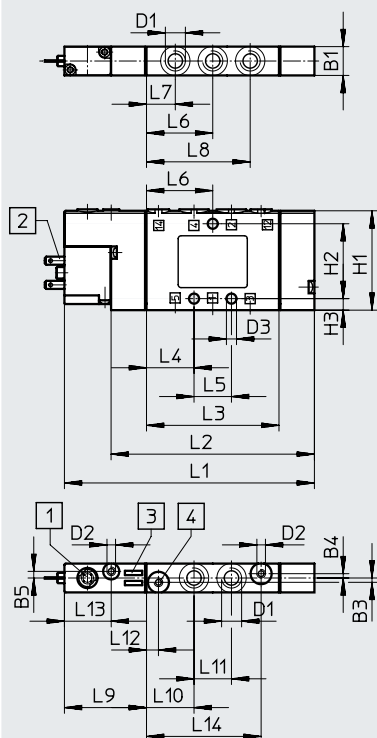

CPE10-...-5L...-QS-6

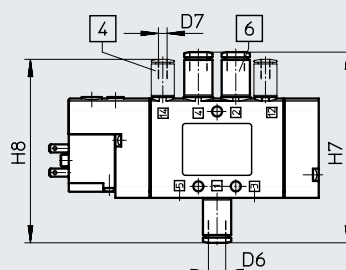

- [1] Manual override, push to reset
- [2] Plug pins, plug pattern ZC
- [3] Space for inscription labels
- [4] Port 12/14 for external pilot air
- [5] M7 to M5 reducer
- [6] QS push-in fitting

| Type             | B1 | B3  | B4  | B5  | D1 | D2 | D3∅ | D4 | D5<br>∅ | D6∅ | D7∅ | H1 | H2 | H3 | H4 | H5   | H6   | H7   | H8   |
|------------------|----|-----|-----|-----|----|----|-----|----|---------|-----|-----|----|----|----|----|------|------|------|------|
| CPE10-M1BH-5L... | 10 | 1.5 | 1.5 | 2.3 | M7 | M3 | 3.5 | M5 | 4       | 6   | 3   | 35 | 26 | 4  | 51 | 62.2 | 61.7 | 66.2 | 63.7 |

| Type             | L1   | L2   | L3 | L4   | L5 | L6 | L7 | L8 | L9   | L10  | L11 | L12 | L13  | L14  |
|------------------|------|------|----|------|----|----|----|----|------|------|-----|-----|------|------|
| CPE10-M1BH-5L... | 86.8 | 70.6 | 46 | 16.5 | 13 | 23 | 10 | 36 | 28.5 | 16.5 | 13  | 4.2 | 16.3 | 39.8 |

Datasheet

Dimensions – 5/2-way double pilot valve and 5/3-way valve

Download CAD data → [www.festo.com](http://www.festo.com)

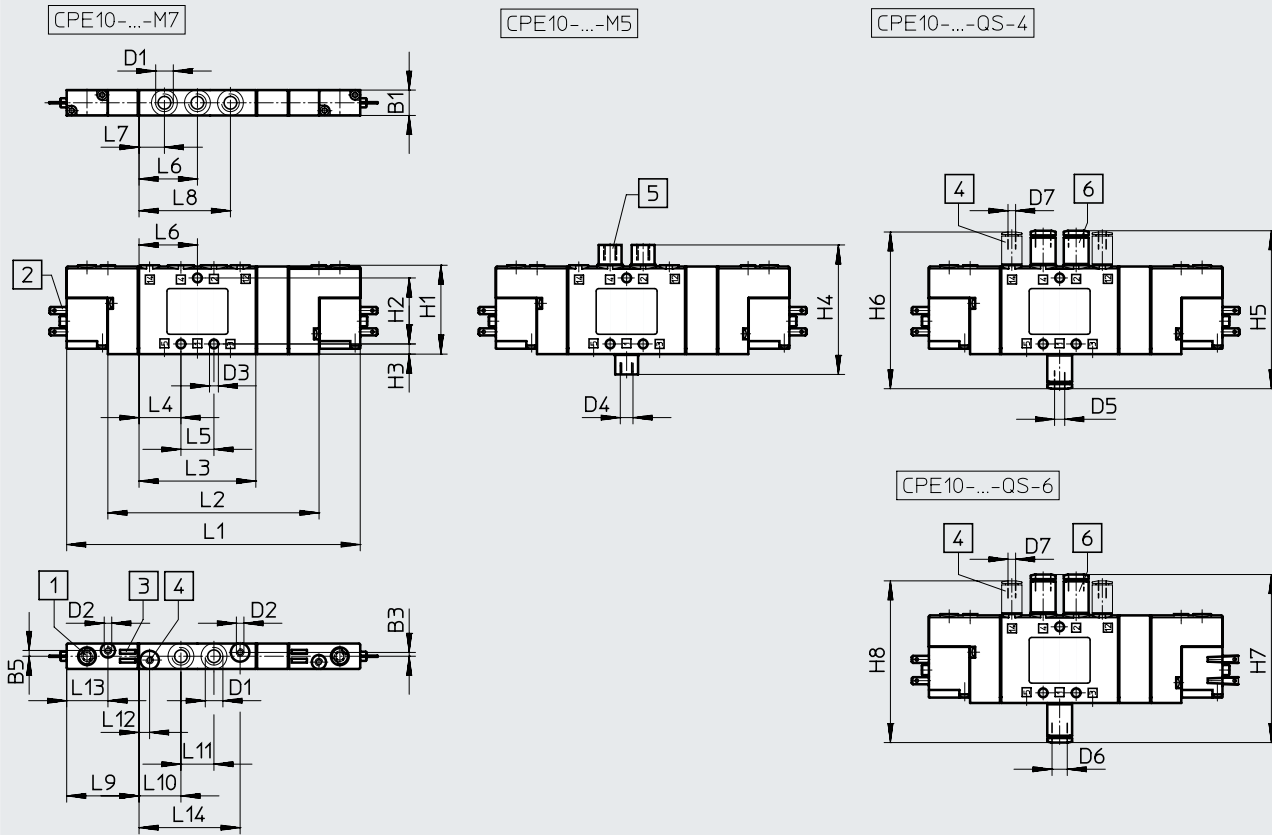

- [1] Manual override, push to reset
- [2] Plug pins, plug pattern ZC
- [3] Space for inscription labels
- [4] Port 12/14 for external pilot air
- [5] M7 to M5 reducer
- [6] QS push-in fitting

| Type           | B1 | B3  | B5  | D1 | D2 | D3 $\varnothing$ | D4 | D5 $\varnothing$ | D6 $\varnothing$ | D7 $\varnothing$ | H1 | H2 | H3 | H4 | H5   | H6   | H7   | H8   |
|----------------|----|-----|-----|----|----|------------------|----|------------------|------------------|------------------|----|----|----|----|------|------|------|------|
| CPE-10-...-5]  | 10 | 1.5 | 2.3 | M7 | M3 | 3.5              | M5 | 4                | 6                | 3                | 35 | 26 | 4  | 51 | 62.2 | 61.7 | 66.2 | 63.7 |
| CPE-10-...-5/3 |    |     |     |    |    |                  |    |                  |                  |                  |    |    |    |    |      |      |      |      |

| Type           | L1    | L2   | L3 | L4   | L5 | L6 | L7 | L8 | L9   | L10  | L11 | L12 | L13  | L14  |
|----------------|-------|------|----|------|----|----|----|----|------|------|-----|-----|------|------|
| CPE-10-...-5]  | 103   | 70.6 | 46 | 16.5 | 13 | 23 | 10 | 36 | 28.5 | 16.5 | 13  | 4.2 | 16.3 | 39.8 |
| CPE-10-...-5/3 | 115.6 | 83.2 |    |      |    |    |    |    |      |      |     |     |      |      |



Datasheet

Dimensions – Solenoid valves with round plug M8x1

Download CAD data → [www.festo.com](http://www.festo.com)

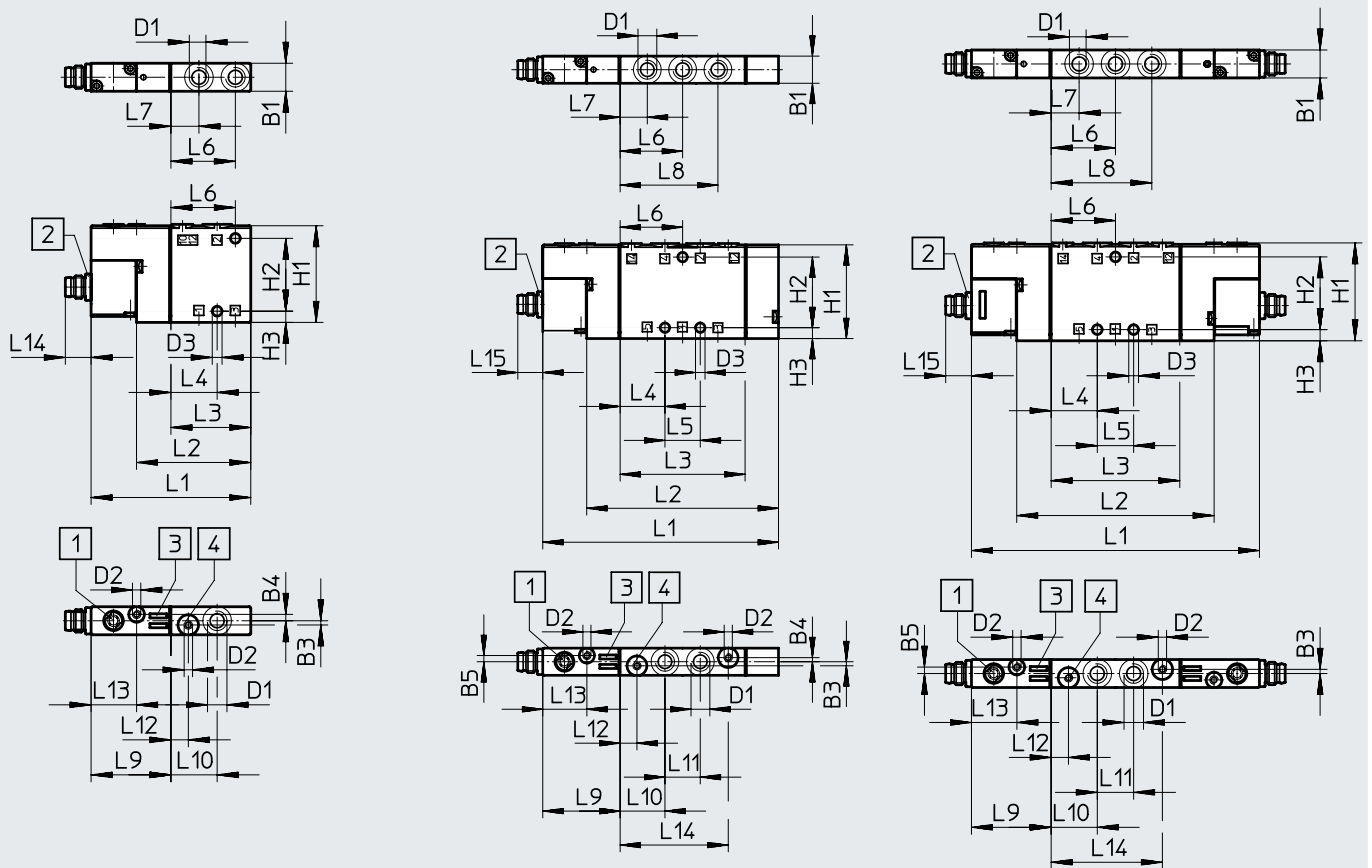

[1] Manual override, push to reset    [2] Plug M8x1    [3] Space for inscription labels    [4] Port 12/14 for external pilot air

| Type              | B1 | B3  | B4  | B5  | D1 | D2 | D3<br>∅ | H1 | H2 | H3 |
|-------------------|----|-----|-----|-----|----|----|---------|----|----|----|
| CPE-10-M1CH-3...  | 10 | 1.5 | 2.3 | –   | M7 | M3 | 3.5     | 35 | 26 | 4  |
| CPE-10-M1CH-5L... |    |     | 1.5 | 2.3 |    |    |         |    |    |    |
| CPE-10-M1CH-5J... |    |     | –   | –   |    |    |         |    |    |    |

| Type              | L1   | L2   | L3   | L4   | L5 | L6 | L7 | L8 | L9   | L10  | L11 | L12 | L13  | L14   | L15 |
|-------------------|------|------|------|------|----|----|----|----|------|------|-----|-----|------|-------|-----|
| CPE-10-M1CH-3...  | 57   | 40.8 | 28.5 | 16.5 | –  | 23 | 10 | –  | 28.5 | 16.5 | –   | 6.2 | 16.3 | 9.2   | –   |
| CPE-10-M1CH-5L... | 86.8 | 70.6 | 46   | –    | 13 | –  | –  | 36 | –    | –    | 13  | –   | –    | 39.82 | 9.2 |
| CPE-10-M1CH-5J... | 103  | –    | –    | –    | –  | –  | –  | –  | –    | –    | –   | –   | –    | –     | –   |

## Ordering data

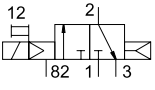
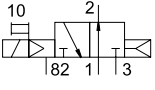
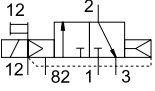
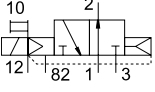
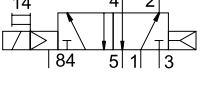
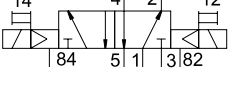
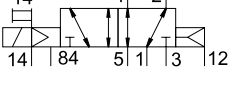
| Ordering data  |                  |                            |                   |                      |            |          |                      |
|--|------------------|----------------------------|-------------------|----------------------|------------|----------|----------------------|
| Circuit symbol   | Pilot air supply | Electrical connection      | Operating voltage | Pneumatic connection | Weight [g] | Part no. | Type                 |
| <b>3/2-way valve, normally closed</b>  |                  |                            |                   |                      |            |          |                      |
|    | Internal         | Plug pins, plug pattern ZC | 24 V DC           | M5                   | –          | 196845   | CPE10-M1BH-3GL-M5    |
|  |                  |                            |                   | M7                   | 40         | 196915   | CPE10-M1BH-3GL-M7    |
|  |                  |                            |                   | QS-4                 | –          | 196846   | CPE10-M1BH-3GL-QS-4  |
|  |                  |                            |                   | QS-6                 | –          | 196847   | CPE10-M1BH-3GL-QS-6  |
|  |                  |                            |                   | M7                   | 40         | 550233   | CPE10-M1CH-3GL-M7    |
|  |                  | Plug M8x1                  |                   |                      |            |          |                      |
| <b>3/2-way valve, normally open</b>  |                  |                            |                   |                      |            |          |                      |
|    | Internal         | Plug pins, plug pattern ZC | 24 V DC           | M5                   | –          | 196851   | CPE10-M1BH-3OL-M5    |
|  |                  |                            |                   | M7                   | 40         | 196917   | CPE10-M1BH-3OL-M7    |
|  |                  |                            |                   | QS-4                 | –          | 196852   | CPE10-M1BH-3OL-QS-4  |
|  |                  |                            |                   | QS-6                 | –          | 196853   | CPE10-M1BH-3OL-QS-6  |
|  |                  |                            |                   | M7                   | 40         | 550235   | CPE10-M1CH-3OL-M7    |
|  |                  | Plug M8x1                  |                   |                      |            |          |                      |
| <b>3/2-way valve, normally closed</b>  |                  |                            |                   |                      |            |          |                      |
|    | External         | Plug pins, plug pattern ZC | 24 V DC           | M5                   | –          | 196848   | CPE10-M1BH-3GLS-M5   |
|  |                  |                            |                   | M7                   | 40         | 196916   | CPE10-M1BH-3GLS-M7   |
|  |                  |                            |                   | QS-4                 | –          | 196849   | CPE10-M1BH-3GLS-QS-4 |
|  |                  |                            |                   | QS-6                 | –          | 196850   | CPE10-M1BH-3GLS-QS-6 |
|  |                  |                            |                   | M7                   | 40         | 550234   | CPE10-M1CH-3GLS-M7   |
|  |                  | Plug M8x1                  |                   |                      |            |          |                      |
| <b>3/2-way valve, normally open</b>  |                  |                            |                   |                      |            |          |                      |
|   | External         | Plug pins, plug pattern ZC | 24 V DC           | M5                   | –          | 196854   | CPE10-M1BH-3OLS-M5   |
|  |                  |                            |                   | M7                   | 40         | 196918   | CPE10-M1BH-3OLS-M7   |
|  |                  |                            |                   | QS-4                 | –          | 196855   | CPE10-M1BH-3OLS-QS-4 |
|  |                  |                            |                   | QS-6                 | –          | 196856   | CPE10-M1BH-3OLS-QS-6 |
|  |                  |                            |                   | M7                   | 40         | 550236   | CPE10-M1CH-3OLS-M7   |
|  |                  | Plug M8x1                  |                   |                      |            |          |                      |
| <b>5/2-way valve, single solenoid</b>  |                  |                            |                   |                      |            |          |                      |
|  | Internal         | Plug pins, plug pattern ZC | 24 V DC           | M5                   | –          | 196881   | CPE10-M1BH-5L-M5     |
|  |                  |                            |                   | M7                   | 56         | 196927   | CPE10-M1BH-5L-M7     |
|  |                  |                            |                   | QS-4                 | –          | 196882   | CPE10-M1BH-5L-QS-4   |
|  |                  |                            |                   | QS-6                 | –          | 196883   | CPE10-M1BH-5L-QS-6   |
|  |                  |                            |                   | M7                   | 56         | 550223   | CPE10-M1CH-5L-M7     |
|  |                  | Plug M8x1                  |                   |                      |            |          |                      |
| <b>5/2-way double pilot valve</b>  |                  |                            |                   |                      |            |          |                      |
|  | Internal         | Plug pins, plug pattern ZC | 24 V DC           | M5                   | –          | 196875   | CPE10-M1BH-5J-M5     |
|  |                  |                            |                   | M7                   | 68         | 196925   | CPE10-M1BH-5J-M7     |
|  |                  |                            |                   | QS-4                 | –          | 196876   | CPE10-M1BH-5J-QS-4   |
|  |                  |                            |                   | QS-6                 | –          | 196877   | CPE10-M1BH-5J-QS-6   |
|  |                  |                            |                   | M7                   | 68         | 550225   | CPE10-M1CH-5J-M7     |
|  |                  | Plug M8x1                  |                   |                      |            |          |                      |
| <b>5/2-way valve, single solenoid</b>  |                  |                            |                   |                      |            |          |                      |
|  | External         | Plug pins, plug pattern ZC | 24 V DC           | M5                   | –          | 196884   | CPE10-M1BH-5LS-M5    |
|  |                  |                            |                   | M7                   | 56         | 196928   | CPE10-M1BH-5LS-M7    |
|  |                  |                            |                   | QS-4                 | –          | 196885   | CPE10-M1BH-5LS-QS-4  |
|  |                  |                            |                   | QS-6                 | –          | 196886   | CPE10-M1BH-5LS-QS-6  |
|  |                  |                            |                   | M7                   | 56         | 550224   | CPE10-M1CH-5LS-M7    |
|  |                  | Plug M8x1                  |                   |                      |            |          |                      |

## Ordering data

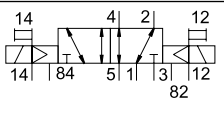
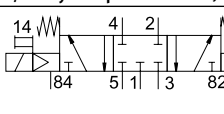
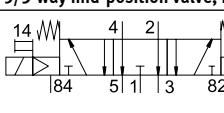
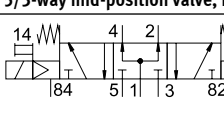
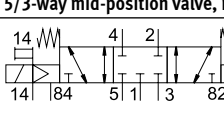
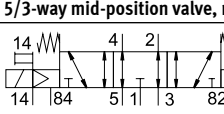
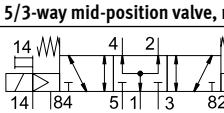
| Ordering data<br>Circuit symbol   | Pilot air<br>supply | Electrical<br>connection      | Operating<br>voltage | Pneumatic<br>connection | Weight<br>[g] | Part no. | Type                    |
|---|---------------------|-------------------------------|----------------------|-------------------------|---------------|----------|-------------------------|
| <b>5/2-way double pilot valve</b>   |                     |                               |                      |                         |               |          |                         |
|    | External            | Plug pins, plug<br>pattern ZC | 24 V DC              | M5                      | –             | 196878   | CPE10-M1BH-5JS-M5       |
|   |                     |                               |                      | M7                      | 68            | 196926   | CPE10-M1BH-5JS-M7       |
|   |                     |                               |                      | QS-4                    | –             | 196879   | CPE10-M1BH-5JS-QS-4     |
|   |                     |                               |                      | QS-6                    | –             | 196880   | CPE10-M1BH-5JS-QS-6     |
|   |                     | Plug M8x1                     |                      | M7                      | 68            | 550226   | CPE10-M1CH-5JS-M7       |
| <b>5/3-way mid-position valve, normally closed</b>                                  |                     |                               |                      |                         |               |          |                         |
|    | Internal            | Plug pins, plug<br>pattern ZC | 24 V DC              | M5                      | –             | 533159   | CPE10-M1BH-5/3G-M5-B    |
|   |                     |                               |                      | M7                      | 68            | 533141   | CPE10-M1BH-5/3G-M7-B    |
|   |                     |                               |                      | QS-4                    | –             | 533147   | CPE10-M1BH-5/3G-QS-4    |
|   |                     |                               |                      | QS-6                    | –             | 533153   | CPE10-M1BH-5/3G-QS-6    |
|   |                     | Plug M8x1                     |                      | M7                      | 68            | 550227   | CPE10-M1CH-5/3G-M7      |
| <b>5/3-way mid-position valve, normally exhausted</b>                               |                     |                               |                      |                         |               |          |                         |
|    | Internal            | Plug pins, plug<br>pattern ZC | 24 V DC              | M5                      | –             | 533161   | CPE10-M1BH-5/3E-M5-B    |
|   |                     |                               |                      | M7                      | 68            | 533143   | CPE10-M1BH-5/3E-M7-B    |
|   |                     |                               |                      | QS-4                    | –             | 533149   | CPE10-M1BH-5/3E-QS-4-B  |
|   |                     |                               |                      | QS-6                    | –             | 533155   | CPE10-M1BH-5/3E-QS-6-B  |
|   |                     | Plug M8x1                     |                      | M7                      | 68            | 550229   | CPE10-M1CH-5/3E-M7      |
| <b>5/3-way mid-position valve, normally open</b>                                    |                     |                               |                      |                         |               |          |                         |
|   | Internal            | Plug pins, plug<br>pattern ZC | 24 V DC              | M5                      | –             | 533163   | CPE10-M1BH-5/3B-M5-B    |
|   |                     |                               |                      | M7                      | 68            | 533145   | CPE10-M1BH-5/3B-M7-B    |
|   |                     |                               |                      | QS-4                    | –             | 533151   | CPE10-M1BH-5/3B-QS-4-B  |
|   |                     |                               |                      | QS-6                    | –             | 533157   | CPE10-M1BH-5/3B-QS-6-B  |
|   |                     | Plug M8x1                     |                      | M7                      | 68            | 550231   | CPE10-M1CH-5/3B-M7      |
| <b>5/3-way mid-position valve, normally closed</b>                                  |                     |                               |                      |                         |               |          |                         |
|  | External            | Plug pins, plug<br>pattern ZC | 24 V DC              | M5                      | –             | 533160   | CPE10-M1BH-5/3GS-M5-B   |
|   |                     |                               |                      | M7                      | 68            | 533142   | CPE10-M1BH-5/3GS-M7-B   |
|   |                     |                               |                      | QS-4                    | –             | 533148   | CPE10-M1BH-5/3GS-QS-4-B |
|   |                     |                               |                      | QS-6                    | –             | 533154   | CPE10-M1BH-5/3GS-QS-6-B |
|   |                     | Plug M8x1                     |                      | M7                      | 68            | 550228   | CPE10-M1CH-5/3GS-M7     |
| <b>5/3-way mid-position valve, normally exhausted</b>                               |                     |                               |                      |                         |               |          |                         |
|  | External            | Plug pins, plug<br>pattern ZC | 24 V DC              | M5                      | –             | 533162   | CPE10-M1BH-5/3ES-M5-B   |
|   |                     |                               |                      | M7                      | 68            | 533144   | CPE10-M1BH-5/3ES-M7-B   |
|   |                     |                               |                      | QS-4                    | –             | 533150   | CPE10-M1BH-5/3ES-QS-4-B |
|   |                     |                               |                      | QS-6                    | –             | 533156   | CPE10-M1BH-5/3ES-QS-6-B |
|   |                     | Plug M8x1                     |                      | M7                      | 68            | 550230   | CPE10-M1CH-5/3ES-M7     |
| <b>5/3-way mid-position valve, normally open</b>                                    |                     |                               |                      |                         |               |          |                         |
|  | External            | Plug pins, plug<br>pattern ZC | 24 V DC              | M5                      | –             | 533164   | CPE10-M1BH-5/3BS-M5-B   |
|   |                     |                               |                      | M7                      | 68            | 533146   | CPE10-M1BH-5/3BS-M7-B   |
|   |                     |                               |                      | QS-4                    | –             | 533152   | CPE10-M1BH-5/3BS-QS-4-B |
|   |                     |                               |                      | QS-6                    | –             | 533158   | CPE10-M1BH-5/3BS-QS-6-B |
|   |                     | Plug M8x1                     |                      | M7                      | 68            | 550232   | CPE10-M1CH-5/3BS-M7     |

## Datasheet – Manifold block

### Manifold block CPE...-PRS

Material:  
Wrought aluminium alloy

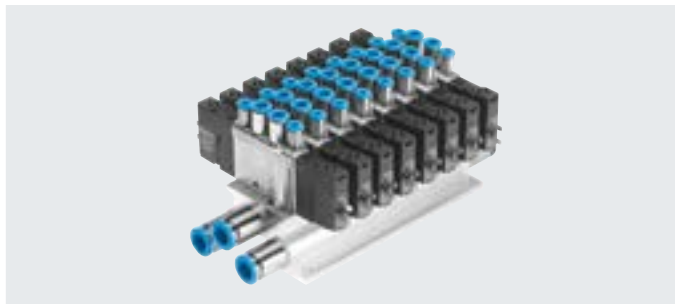

#### Dimensions – Fixed-grid manifold 5/2 and 5/3

Download CAD data → [www.festo.com](http://www.festo.com)

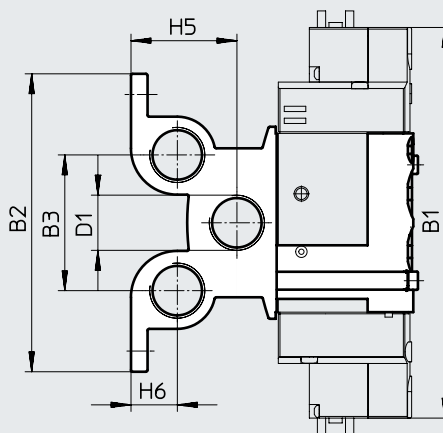
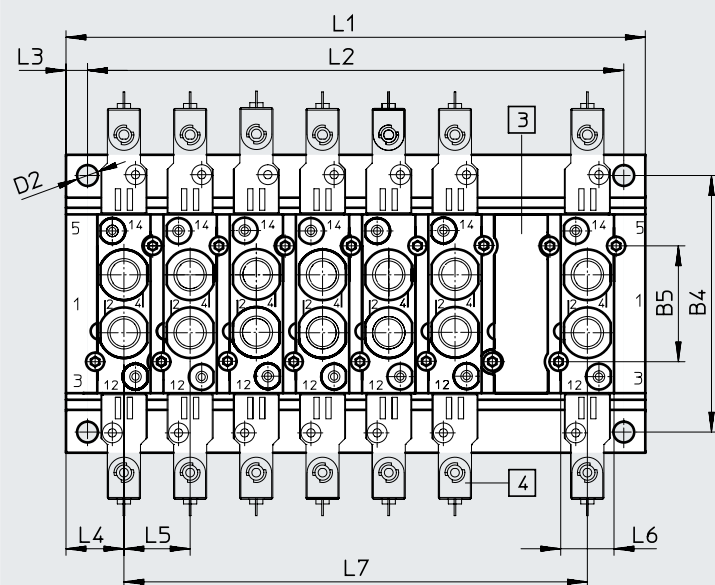
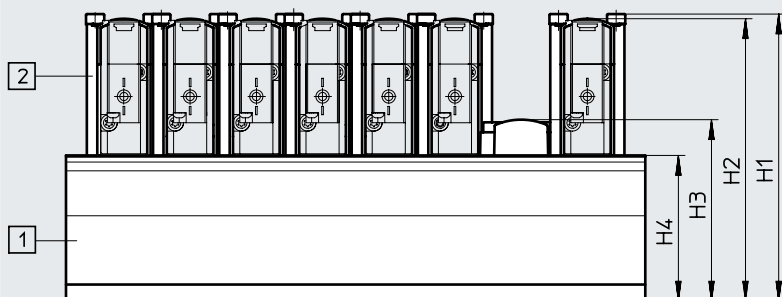

[1] Manifold block

[2] Retaining bracket

[3] Cover plate

[4] Valves

| Type         | B1  | B2 | B3 | B4   | B5 | D1   | D2<br>∅ | H1 | H2   | H3   | H4 | H5   | H6 |
|--------------|-----|----|----|------|----|------|---------|----|------|------|----|------|----|
| CPE10-PRS... | 103 | 79 | 35 | 67.5 | 26 | G1/4 | 5.3     | 72 | 69.5 | 44.8 | 34 | 23.5 | 11 |



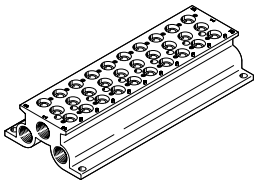

| Type         | L1              | L2            | L3  | L4 | L5 | L6   | L7         |
|--------------|-----------------|---------------|-----|----|----|------|------------|
| CPE10-PRS... | 28 + (n-1) x 16 | L1 - 11 ± 0.1 | 5.5 | 14 | 16 | 13.4 | (n-1) x 16 |

## Ordering data – Fixed-grid manifold block

| Ordering data   | Valve positions | CRC <sup>1)</sup> | Max. tightening torque [Nm] | Weight [g] | Part no. | Type             |
|---|-----------------|-------------------|-----------------------------|------------|----------|------------------|
| <b>Manifold block for 5/2- and 5/3-way valves</b>                                 |                 |                   |                             |            |          |                  |
|  | 2               | 2                 | 1.2                         | 131        | 543821   | CPE10-PRS-1/4-2  |
|   | 3               |                   |                             | 179        | 543822   | CPE10-PRS-1/4-3  |
|   | 4               |                   |                             | 227        | 543823   | CPE10-PRS-1/4-4  |
|   | 5               |                   |                             | 275        | 543824   | CPE10-PRS-1/4-5  |
|   | 6               |                   |                             | 323        | 543825   | CPE10-PRS-1/4-6  |
|   | 7               |                   |                             | 371        | 543826   | CPE10-PRS-1/4-7  |
|   | 8               |                   |                             | 419        | 543827   | CPE10-PRS-1/4-8  |
|   | 9               |                   |                             | 467        | 543828   | CPE10-PRS-1/4-9  |
|   | 10              |                   |                             | 515        | 543829   | CPE10-PRS-1/4-10 |

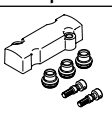
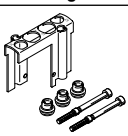
1) Corrosion resistance class CRC 2 to Festo standard FN 940070

Moderate corrosion stress. Indoor applications in which condensation can occur. External visible parts with primarily decorative surface requirements which are in direct contact with a normal industrial environment.

| Ordering data   | Material  | Part no. | Type             |
|---|---|----------|------------------|
| <b>Cover plate for vacant position</b>  |   |          |                  |
|    | PA  | 544479   | CPE10-RP         |
| <b>Retaining bracket set</b>  |   |          |                  |
|   | Retaining bracket: high-alloy stainless steel<br>Screws: galvanised steel<br>Seals: NBR | 544394   | CPE10-H5-SET     |
| <b>Ordering data</b>  |   |          |                  |
| <b>Retaining bracket</b>  |   |          |                  |
|  | Retaining bracket: high-alloy stainless steel<br>(packaging unit 50 pieces)             | 547045   | CPE10-H5-50      |
| <b>Screws</b>   |   |          |                  |
|  | Galvanised steel<br>(packaging unit 100 pieces)   | 547048   | M3X40-8.8-VS-100 |
| <b>Seals</b>  |   |          |                  |
|  | NBR<br>(packaging unit 150 pieces)  | 547051   | CPV10-VI-PM7-150 |

## Technical data – Fixed-grid manifold block

### Manifold block

For CPE10 3/2

### Material:

Wrought aluminium alloy

RoHS-compliant

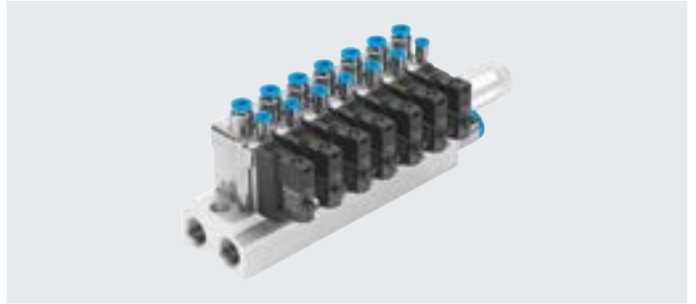

### Dimensions – Fixed-grid manifold block 3/2

Download CAD data → [www.festo.com](http://www.festo.com)

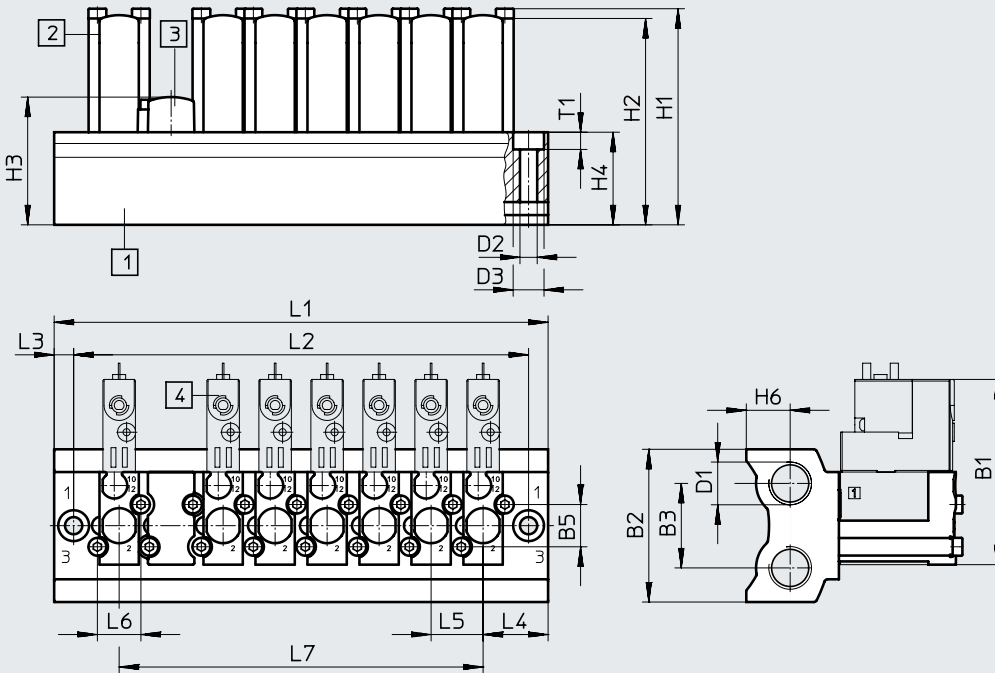

[1] Manifold block

[2] Retaining bracket

[3] Cover plate

[4] Valves

| Type             | B1 | B2 | B3 | B5 | D1   | D2<br>∅ | D3<br>∅ | H1   | H2   | H3   | H4   | H6   |
|------------------|----|----|----|----|------|---------|---------|------|------|------|------|------|
| CPE10-3/2-PRS... | 57 | 47 | 26 | 13 | G1/4 | 5.3     | 9.5     | 66.5 | 63.5 | 39.3 | 28.5 | 13.5 |

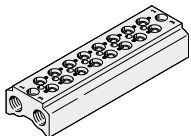

| Type             | L1              | L2              | L3 | L4 | L5 | L6   | L7         | T1  |
|------------------|-----------------|-----------------|----|----|----|------|------------|-----|
| CPE10-3/2-PRS... | 40 + (n-1) x 16 | 28 + (n-1) x 16 | 6  | 20 | 16 | 13.4 | (n-1) x 16 | 5.3 |

## Ordering data – Fixed-grid manifold block

| Ordering data   | Valve positions | CRC <sup>1)</sup> | Max. tightening torque for valve mounting [Nm] | Weight [g] | Part no. | Type                 |
|---|-----------------|-------------------|--|------------|----------|----------------------|
| <b>Manifold block for 3/2-way valves</b>  |                 |                   |  |            |          |                      |
|  | 2               | 2                 | 1.2  | 128        | 550550   | CPE10-3/2-PRS-1/4-2  |
|   | 3               |                   |  | 164        | 550551   | CPE10-3/2-PRS-1/4-3  |
|   | 4               |                   |  | 201        | 550552   | CPE10-3/2-PRS-1/4-4  |
|   | 5               |                   |  | 237        | 550553   | CPE10-3/2-PRS-1/4-5  |
|   | 6               |                   |  | 274        | 550554   | CPE10-3/2-PRS-1/4-6  |
|   | 7               |                   |  | 310        | 550555   | CPE10-3/2-PRS-1/4-7  |
|   | 8               |                   |  | 347        | 550556   | CPE10-3/2-PRS-1/4-8  |
|   | 9               |                   |  | 383        | 550557   | CPE10-3/2-PRS-1/4-9  |
|   | 10              |                   |  | 420        | 550558   | CPE10-3/2-PRS-1/4-10 |

1) Corrosion resistance class CRC 2 to Festo standard FN 940070

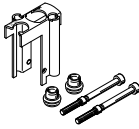
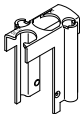
Moderate corrosion stress. Indoor applications in which condensation can occur. External visible parts with primarily decorative surface requirements which are in direct contact with a normal industrial environment.

| Ordering data   | Material  | Part no. | Type              |
|---|---|----------|-------------------|
| <b>Cover plate</b>  |   |          |                   |
|    | PA<br>RoHS-compliant  | 550580   | CPE10-RP3         |
| <b>Retaining bracket set</b>  |   |          |                   |
|  | Retaining bracket: high-alloy stainless steel<br>Screws: galvanised steel<br>Seals: NBR<br>RoHS-compliant | 550577   | CPE10-H3-SET      |
| <b>Ordering data</b>  |   |          |                   |
| <b>Retaining bracket</b>  |   |          |                   |
|  | Retaining bracket: high-alloy stainless steel<br>(packaging unit 50 pieces)                               | 551490   | CPE10-H3-50       |
| <b>Screws</b>   |   |          |                   |
|  | Galvanised steel<br>(packaging unit 100 pieces)   | 547048   | M3X40-8.8-VS-100  |
| <b>Seals</b>  |   |          |                   |
|  | NBR<br>(packaging unit 150 pieces)  | 547051   | CPV10-VI-P.M7-150 |

Technical data – Modular manifold

**Modular manifold block**

For CPE18 5/2 and 5/3

Material:  
Reinforced PA

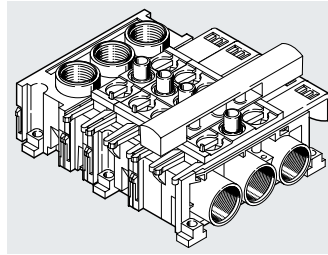

**Dimensions – Modular manifold block**

Download CAD data → [www.festo.com](http://www.festo.com)

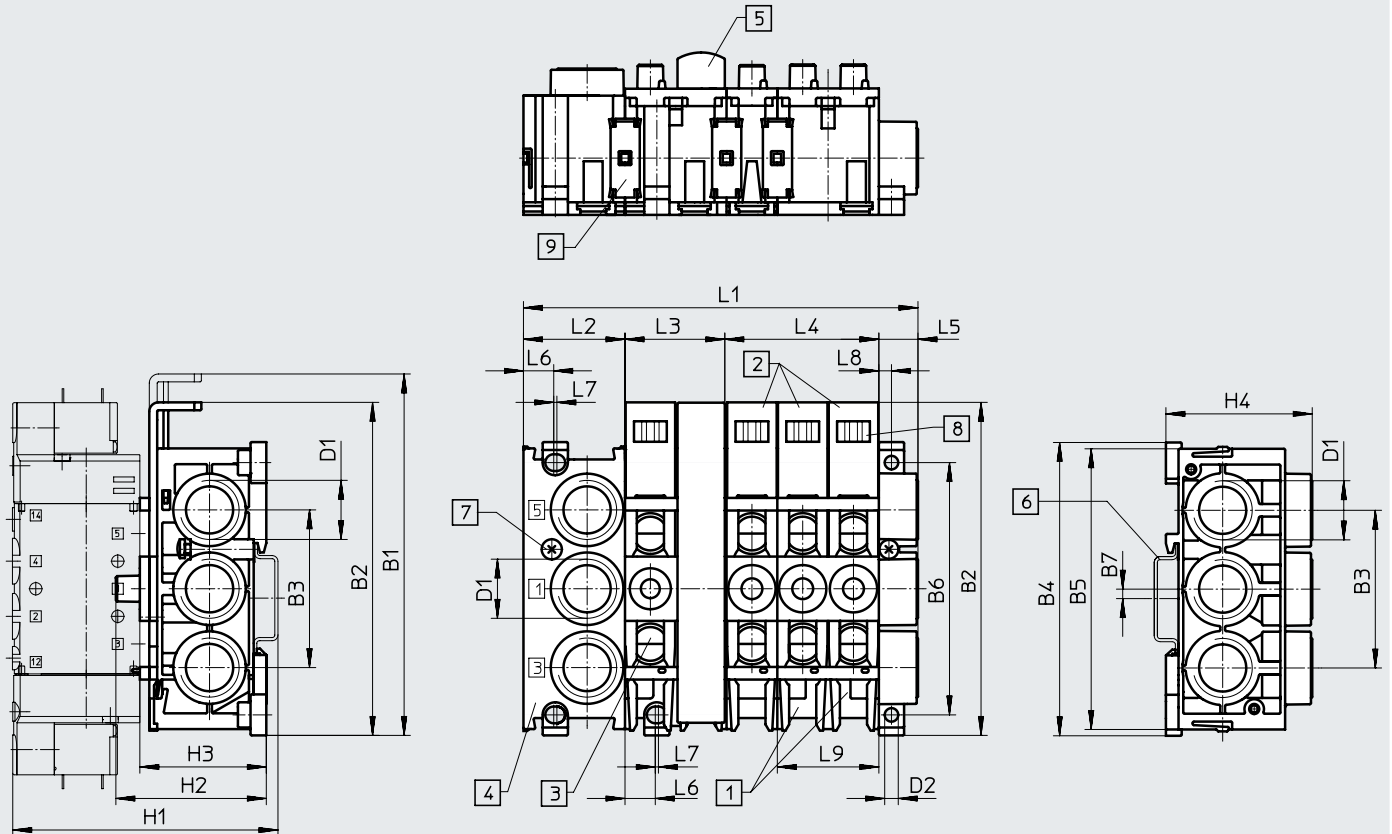

- [1] Manifold block CPE...-PRSG...-2 for 2 valves
- [2] Manifold block CPE...-PRSG...-3 for 3 valves
- [3] Expansion block CPE...-PRSE...-2 for 2 valves
- [4] End block CPE...-PRS-EP
- [5] Cover plate CPE...-PRSB
- [6] H-rail to EN 50002 for mounting
- [7] Clamping screw for H-rail
- [8] Location for inscription label type IBS 6 x 10
- [9] Connecting component

| Size  | B1   | B2 | B3 | B4 | B5 | B6 | B7 | D1   | D2<br>∅ | H1  | H2  | H3  | H4 |
|-------|------|----|----|----|----|----|----|------|---------|-----|-----|-----|----|
| CPE10 | 93.5 | 87 | 37 | 73 | 71 | 60 | 7  | G1/4 | 3.3     | ~72 | ~40 | ~34 | 37 |

| Size  | L1 <sup>1)</sup> |  |  | L2 | L3 | L4 | L5   | L6  | L7 | L8  | L9 |
|-------|------------------|--|--|----|----|----|------|-----|----|-----|----|
| CPE10 | 24+(nx12)+11.4   |  |  | 24 | 24 | 36 | 11.4 | 9.6 | -  | 3.2 | 24 |

1) n = number of valve positions



## Technical data – Modular manifold

| Combination options<br>Number of valve positions | One pressure zone  | Two pressure zones  |  |
|--|--|---|--|
|  |  | Variant 1   | Variant 2  |
| 2  | 1x CPE...-PRSG-2   | –   | –  |
| 3  | 1x CPE...-PRSG-3   | –   | –  |
| 4  | 1x CPE...-PRSGO-2<br>1x CPE...-PRSE-2                      | 1x CPE...-PRSG-2<br>1x CPE...-PRSEO-2<br>1x CPE...-PRS-EP | –  |
| 5  | 1x CPE...-PRSGO-3<br>1x CPE...-PRSE-2                      | 1x CPE...-PRSG-3<br>1x CPE...-PRSEO-2<br>1x CPE...-PRS-EP | –  |
| 6  | 1x CPE...-PRSGO-2<br>1x CPE...-PRSEO-2<br>1x CPE...-PRSE-2 | 1x CPE...-PRSG-2<br>2x CPE...-PRSEO-2<br>1x CPE...-PRS-EP | 1x CPE...-PRSGO-2<br>1x CPE...-PRSE-2<br>1x CPE...-PRSEO-2<br>1x CPE...-PRS-EP |
| 7  | 1x CPE...-PRSGO-3<br>2x CPE...-PRSEO-2<br>1x CPE...-PRS-EP | 1x CPE...-PRSG-3<br>2x CPE...-PRSEO-2<br>1x CPE...-PRS-EP | 1x CPE...-PRSGO-3<br>1x CPE...-PRSE-2<br>1x CPE...-PRSEO-2<br>1x CPE...-PRS-EP |
| 8  | 1x CPE...-PRSGO-2<br>3x CPE...-PRSEO-2<br>1x CPE...-PRS-EP | 1x CPE...-PRSG-2<br>3x CPE...-PRSEO-2<br>1x CPE...-PRS-EP | 1x CPE...-PRSGO-2<br>1x CPE...-PRSE-2<br>2x CPE...-PRSEO-2<br>1x CPE...-PRS-EP |
| 9  | 1x CPE...-PRSGO-3<br>3x CPE...-PRSEO-2<br>1x CPE...-PRS-EP | 1x CPE...-PRSG-3<br>3x CPE...-PRSEO-2<br>1x CPE...-PRS-EP | 1x CPE...-PRSGO-3<br>1x CPE...-PRSE-2<br>2x CPE...-PRSEO-2<br>1x CPE...-PRS-EP |
| 10   | 1x CPE...-PRSGO-2<br>4x CPE...-PRSEO-2<br>1x CPE...-PRS-EP | 1x CPE...-PRSG-2<br>4x CPE...-PRSEO-2<br>1x CPE...-PRS-EP | 1x CPE...-PRSGO-2<br>1x CPE...-PRSE-2<br>3x CPE...-PRSEO-2<br>1x CPE...-PRS-EP |
| 11   | 1x CPE...-PRSGO-3<br>4x CPE...-PRSEO-2<br>1x CPE...-PRS-EP | 1x CPE...-PRSG-3<br>4x CPE...-PRSEO-2<br>1x CPE...-PRS-EP | 1x CPE...-PRSGO-3<br>1x CPE...-PRSE-2<br>3x CPE...-PRSEO-2<br>1x CPE...-PRS-EP |
| 12   | 1x CPE...-PRSGO-2<br>5x CPE...-PRSEO-2<br>1x CPE...-PRS-EP | 1x CPE...-PRSG-2<br>5x CPE...-PRSEO-2<br>1x CPE...-PRS-EP | 1x CPE...-PRSGO-2<br>1x CPE...-PRSE-2<br>4x CPE...-PRSEO-2<br>1x CPE...-PRS-EP |

 **Note**

Each air supply can support a maximum of 6 valve positions. Use valve manifold blocks only in combination with 5/2- and 5/3-way valves.

## Type codes

| 001 | Series                              |
|-----|-------------------------------------|
| CPE | Solenoid valve, Compact Performance |

| 002 | Width |
|-----|-------|
| 14  | 14 mm |

| 003 | Nominal operating voltage |
|-----|---------------------------|
| M1  | 24 V DC                   |

| 004 | Electrical connection |
|-----|-----------------------|
| BH  | Plug pattern ZC       |
| CH  | Plug M8x1             |



| 005  | Valve function                          |
|------|---|
| 5L   | 5/2-way valve, monostable               |
| 5J   | 5/2-way valve, bistable                 |
| 3GL  | 3/2-way valve, normally closed          |
| 3OL  | 3/2-way valve, normally open            |
| 5/3G | 5/3-way valve, mid-position closed      |
| 5/3E | 5/3-way valve, mid-position exhausted   |
| 5/3B | 5/3-way valve, mid-position pressurised |

| 006 | Pilot air |
|-----|-----------|
|     | Internal  |
| S   | External  |

| 007  | Pneumatic connection   |
|------|------------------------|
| 1/8  | G1/8                   |
| QS-6 | Push-in connector 6 mm |
| QS-8 | Push-in connector 8 mm |

# Datasheet

Function  
 3/2G, 3/2O,  
 5/2-way single solenoid  
 5/2-way double pilot valve  
 5/3G, 5/3B, 5/3E

-  - Width 14 mm
-  - Flow rate  
370 ... 900 l/min
-  - Voltage  
24 V DC

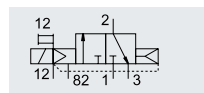

e.g. 3/2-way valve with external pilot air supply, normally closed

| General technical data                       |         |         | 3/2  |                 | 5/2                                       |          | 5/3             |                 |                 |  |
|--|---------|---------|--|-----------------|---|----------|-----------------|-----------------|-----------------|--|
| Valve function                               |         |         | G <sup>1)</sup>  | O <sup>2)</sup> | -   | -        | G <sup>1)</sup> | B <sup>2)</sup> | E <sup>3)</sup> |  |
| Normal position                              |         |         | Monostable   |                 |   | Bistable |                 | Monostable      |                 |  |
| Stable position                              |         |         | Yes  |                 |   | -        |                 | No              |                 |  |
| Pneumatic spring reset                       |         |         | No   |                 |   | -        |                 | Yes             |                 |  |
| Mechanical spring reset                      |         |         | Piston spool   |                 |   |          |                 |                 |                 |  |
| Design                                       |         |         | Soft   |                 |   |          |                 |                 |                 |  |
| Sealing principle                            |         |         | Positive overlap                                       |                 |   |          |                 |                 |                 |  |
| Overlap                                      |         |         | Electrical   |                 |   |          |                 |                 |                 |  |
| Actuation type                               |         |         | Piloted  |                 |   |          |                 |                 |                 |  |
| Type of control                              |         |         | Internal or external                                   |                 |   |          |                 |                 |                 |  |
| Pilot air supply                             |         |         | -  |                 | Reversible with external pilot air supply |          |                 |                 |                 |  |
| Flow direction                               |         |         | -  |                 | Can be throttled                          |          |                 |                 |                 |  |
| Exhaust function                             |         |         | Non-detenting, detenting via accessory                 |                 |   |          |                 |                 |                 |  |
| Manual override                              |         |         | Via through-holes                                      |                 |   |          |                 |                 |                 |  |
| Type of mounting                             |         |         | Any  |                 |   |          |                 |                 |                 |  |
| Mounting position                            |         |         | Threaded connection: G1/8 QS connection: Ø 6 or Ø 8 mm |                 |   |          |                 |                 |                 |  |
| Pneumatic connection                         | 1, 2, 4 |         | Threaded connection: G1/8                              |                 |   |          |                 |                 |                 |  |
|  | 3, 5    |         | Threaded connection: M3, QS connection: Ø 3 mm         |                 |   |          |                 |                 |                 |  |
|  | 12, 14  |         | Threaded connection: M3                                |                 |   |          |                 |                 |                 |  |
|  | 82, 84  |         |  |                 |   |          |                 |                 |                 |  |
| Nominal width                                | [mm]    | 6       |  |                 |   |          |                 |                 |                 |  |
| Standard nominal flow rate                   | G1/8    | [l/min] | 900  |                 | 800                                       |          | 750             |                 | 700             |  |
| Standard nominal flow rate                   | QS6     | [l/min] | 510  |                 | 400                                       |          | 410             |                 | 370             |  |
| Standard nominal flow rate                   | QS8     | [l/min] | 810  |                 | 680                                       |          | 720             |                 | 650 570         |  |
| Switching time on/off                        |         | [ms]    | 1 6/27   |                 | 2 4/32                                    |          | -               |                 | 2 0/42          |  |
| Changeover time                              |         | [ms]    | -  |                 | -   |          | 12              |                 | -               |  |
| Duty cycle                                   |         | [%]     | 100  |                 |   |          |                 |                 |                 |  |
| Width  |         | [mm]    | 14   |                 |   |          |                 |                 |                 |  |
| Corrosion resistance class CRC <sup>4)</sup> |         |         | 2  |                 |   |          |                 |                 |                 |  |

1) G = normally closed  
 2) O, B = normally open  
 3) E = normally exhausted  
 4) Corrosion resistance class CRC 2 to Festo standard FN 940070  
 Moderate corrosion stress. Indoor applications in which condensation can occur. External visible parts with primarily decorative surface requirements which are in direct contact with a normal industrial environment.

## Datasheet

| Operating and environmental conditions |                           | 3/2  | 5/2-way, single solenoid | 5/2-way, double solenoid | 5/3         |             |
|--|---------------------------|--|--------------------------|--------------------------|-------------|-------------|
| Valve function                         |                           | 3/2  | 5/2-way, single solenoid | 5/2-way, double solenoid | 5/3         |             |
| Operating medium                       |                           | Compressed air to ISO 8573-1:2010 [7:4:4]  |                          |                          |             |             |
| Pilot medium                           |                           | Compressed air to ISO 8573-1:2010 [7:4:4]  |                          |                          |             |             |
| Note on the operating/pilot medium     |                           | Lubricated operation possible (in which case lubricated operation will always be required) |                          |                          |             |             |
| Operating pressure                     | Internal pilot air supply | [MPa]  | 0.25 ... 0.8             | 0.3 ... 0.8              | 0.2 ... 0.8 | 0.3 ... 0.8 |
|  |                           | [bar]  | 2.5 ... 8                | 3 ... 8                  | 2 ... 8     | 3 ... 8     |
|  | External pilot air supply | [MPa]  | -0.09 ... 1              |                          |             |             |
|  |                           | [bar]  | -0.9 ... 10              |                          |             |             |
| Pilot pressure                         |                           | [MPa]  | 0.25 ... 0.8             | 0.3 ... 0.8              | 0.2 ... 0.8 | 0.3 ... 0.8 |
|  |                           | [bar]  | 2.5 ... 8                | 3 ... 8                  | 2 ... 8     | 3 ... 8     |
| Ambient temperature                    |                           | [°C]   | -5 ... +50               |                          |             |             |
| Temperature of medium                  |                           | [°C]   | -5 ... +50               |                          |             |             |
| Certification for solenoid valves      |                           | c UL us - Recognized (OL) (not with M1CH...)   |                          |                          |             |             |
| Maritime classification <sup>1)</sup>  |                           | See certificate  |                          |                          |             |             |

1) Additional information: [www.festo.com/sp](http://www.festo.com/sp) → Certificates.

| Electrical data                            |            |        |   |
|--|------------|--------|---|
| Operating voltage                          | M1BH, M1CH | [V DC] | 24 +10/-15%                                       |
| Power consumption                          | M1BH, M1CH | [W]    | 1.28  |
| Degree of protection with plug socket      |            |        | IP65 to IEC 60529<br>M1CH: IP65/IP67 to IEC 60529 |
| Max. tightening torque of plug socket M8x1 | M1CH       | [Nm]   | 0.4   |

### Materials

Sectional view

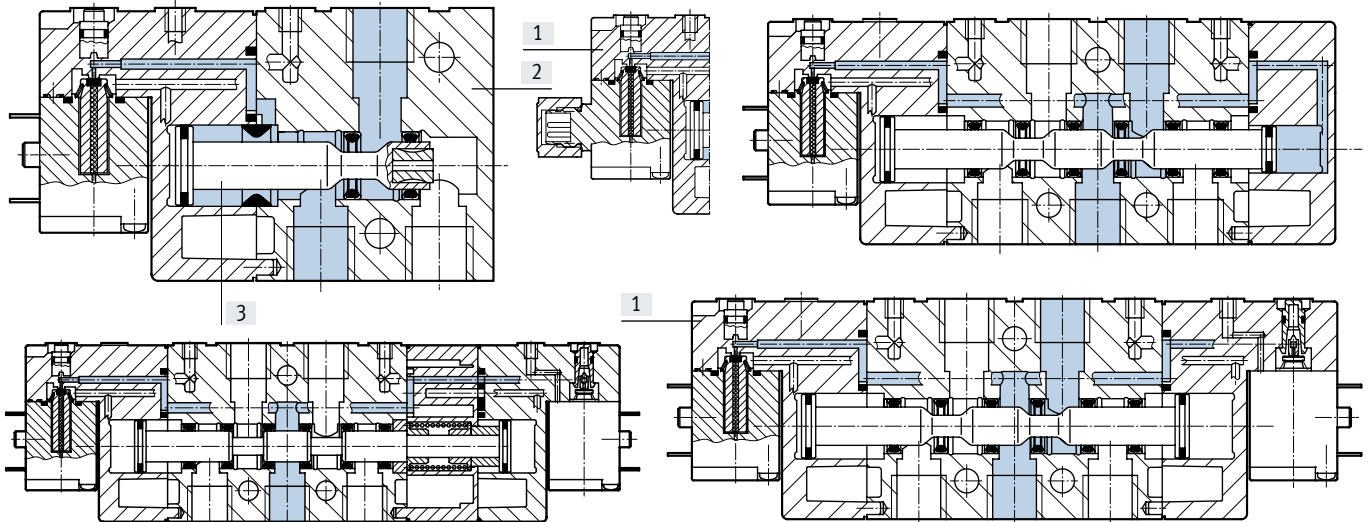

|                   |              |                    |
|-------------------|--------------|--------------------|
| [1]               | Cover        | PA                 |
| [2]               | Housing      | Die-cast aluminium |
| [3]               | Piston spool | Steel              |
| -                 | Seals        | NBR                |
| Note on materials |              | RoHS-compliant     |

Datasheet

Dimensions – 3/2-way valve

Download CAD data → [www.festo.com](http://www.festo.com)

CPE14-...-1/8

CPE14-...-QS-6

CPE14-...-QS-8

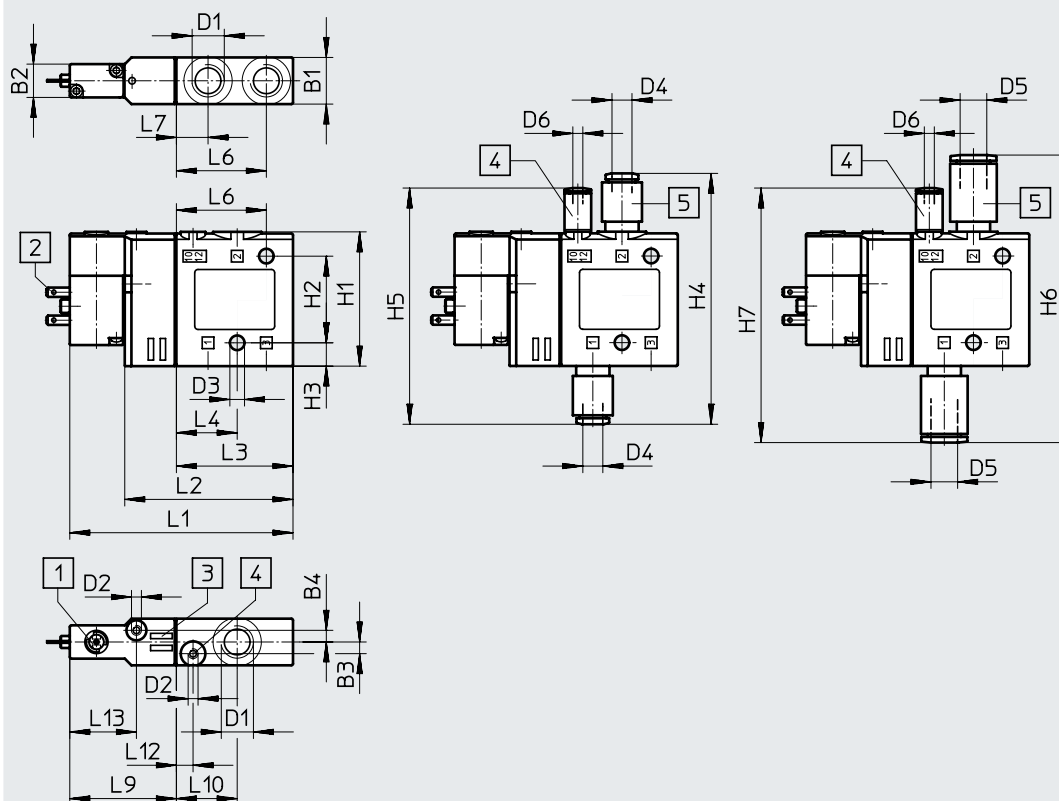

- [1] Manual override
- [2] Plug pins, plug pattern ZC
- [3] Space for inscription labels
- [4] Port 10/12 for external pilot air supply
- [5] QS push-in fitting

| Type            | B1 | B2 | B3  | B4  | D1   | D2 | D3 ø | D4 ø | D5 ø | D6 ø | H1   | H2 | H3 | H4   | H5   | H6   | H7   |
|-----------------|----|----|-----|-----|------|----|------|------|------|------|------|----|----|------|------|------|------|
| CPE14-M1BH-3... | 14 | 10 | 3.5 | 3.5 | G1/8 | M3 | 4.4  | 6    | 8    | 3    | 40.3 | 26 | 7  | 75.3 | 70.9 | 86.3 | 76.4 |

| Type            | L1 | L2   | L3 | L4   | L6 | L7  | L9 | L10 | L12 | L13 |
|-----------------|----|------|----|------|----|-----|----|-----|-----|-----|
| CPE14-M1BH-3... | 67 | 50.5 | 35 | 18.3 | 27 | 9.5 | 32 | 18  | 5   | 20  |

Datasheet

Dimensions – 5/2-way single solenoid valve

Download CAD data → [www.festo.com](http://www.festo.com)

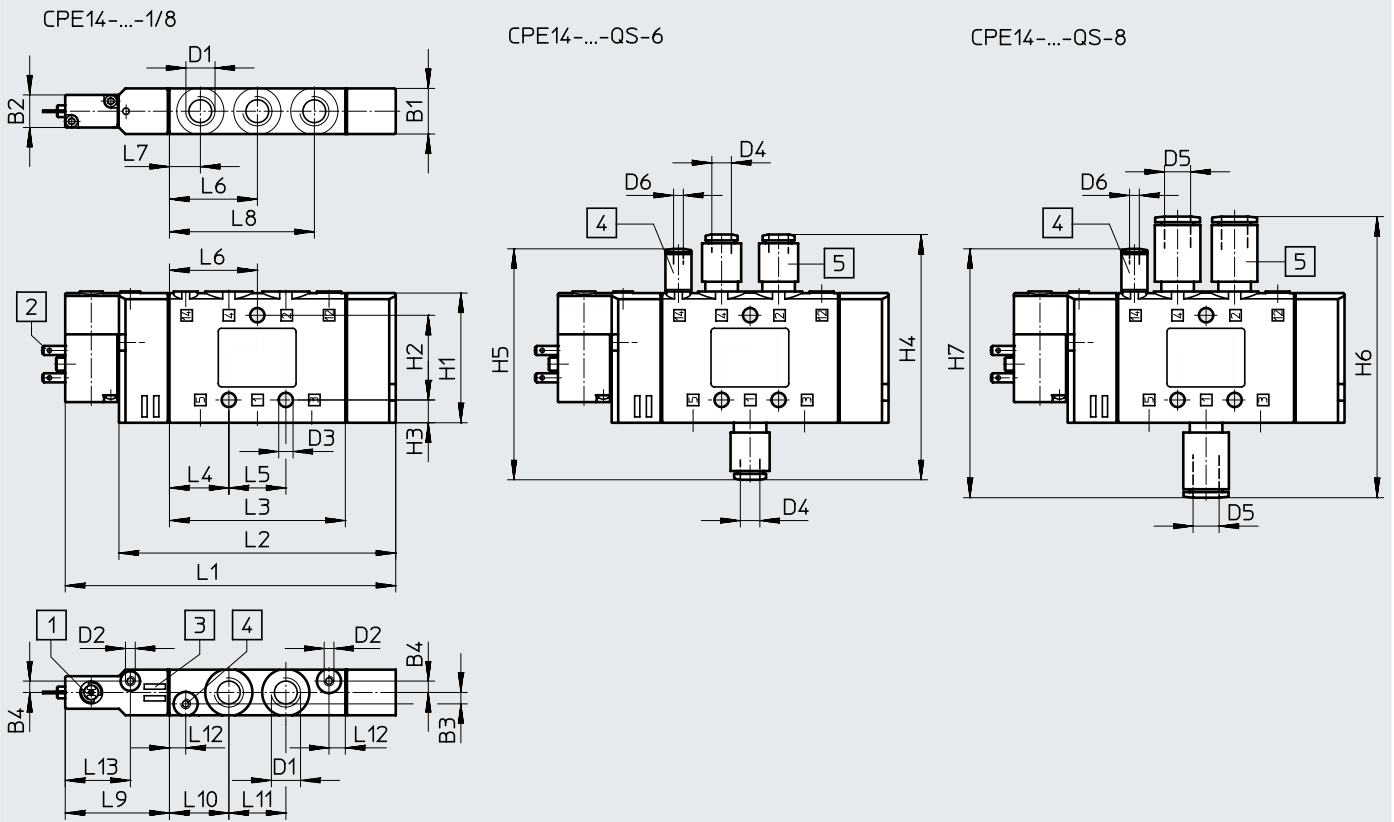

- [1] Manual override
- [2] Plug pins, plug pattern ZC
- [3] Space for inscription labels
- [4] Port 12/14 for external pilot air supply
- [5] QS push-in fitting

| Type             | B1 | B2 | B3  | B4  | D1   | D2 | D3 ø | D4 ø | D5 ø | D6 ø | H1   | H2 | H3 | H4   | H5   | H6   | H7   |
|------------------|----|----|-----|-----|------|----|------|------|------|------|------|----|----|------|------|------|------|
| CPE14-M1BH-5L... | 14 | 10 | 3.5 | 3.5 | G1/8 | M3 | 4.4  | 6    | 8    | 3    | 40.3 | 26 | 7  | 75.3 | 70.9 | 86.3 | 76.4 |

| Type             | L1    | L2 | L3 | L4   | L5   | L6 | L7  | L8   | L9 | L10  | L11  | L12 | L13 |
|------------------|-------|----|----|------|------|----|-----|------|----|------|------|-----|-----|
| CPE14-M1BH-5L... | 101.5 | 85 | 54 | 18.3 | 17.5 | 27 | 9.5 | 44.5 | 32 | 18.3 | 17.5 | 5   | 20  |

Datasheet

Dimensions – 5/2-way double solenoid valve

Download CAD data → [www.festo.com](http://www.festo.com)

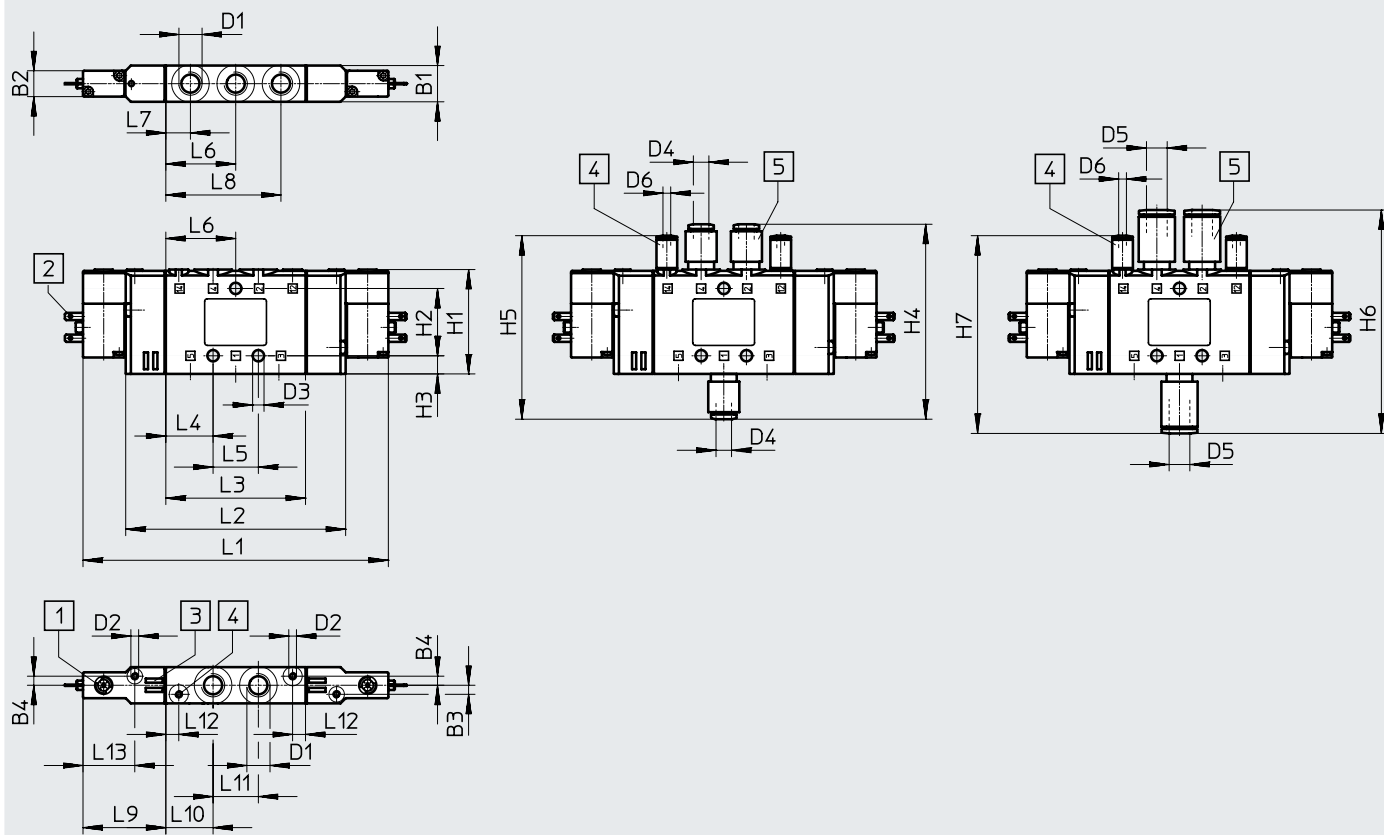

- [1] Manual override, push to reset
- [2] Plug pins, plug pattern ZC
- [3] Space for inscription labels
- [4] Port 12/14 for external pilot air supply
- [5] QS push-in fitting

| Type              | B1 | B2 | B3  | B4  | D1   | D2 | D3 ø | D4 ø | D5 ø | D6 ø | H1   | H2 | H3 | H4   | H5   | H6   | H7   |
|-------------------|----|----|-----|-----|------|----|------|------|------|------|------|----|----|------|------|------|------|
| CPE14-....-5J-1/8 | 14 | 10 | 3.5 | 3.5 | G1/8 | M3 | 4.4  | 6    | 8    | 3    | 40.3 | 26 | 7  | 75.3 | 70.9 | 86.3 | 76.4 |

| Type              | L1  | L2 | L3 | L4   | L5   | L6 | L7  | L8   | L9 | L10  | L11  | L12 | L13 |
|-------------------|-----|----|----|------|------|----|-----|------|----|------|------|-----|-----|
| CPE14-....-5J-1/8 | 118 | 85 | 54 | 18.3 | 17.5 | 27 | 9.5 | 44.5 | 32 | 18.3 | 17.5 | 5   | 20  |

Datasheet

Dimensions – 5/3-way valve

Download CAD data → [www.festo.com](http://www.festo.com)

CPE14-...-1/8

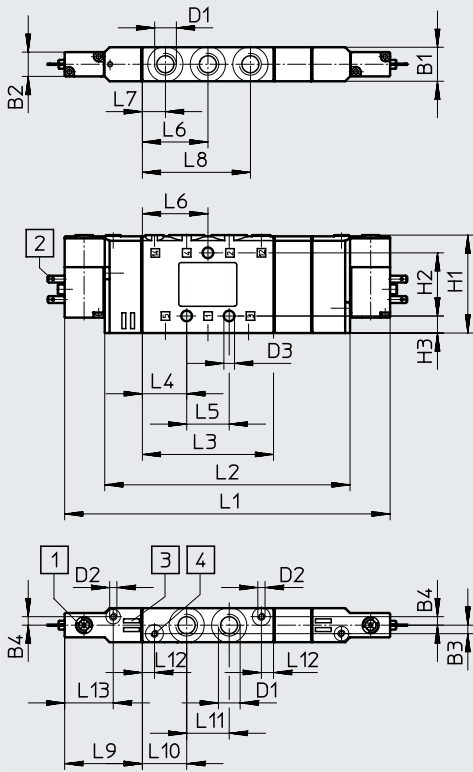

CPE14-...-QS-6

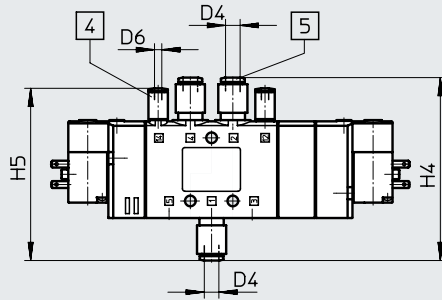

CPE14-...-QS-8

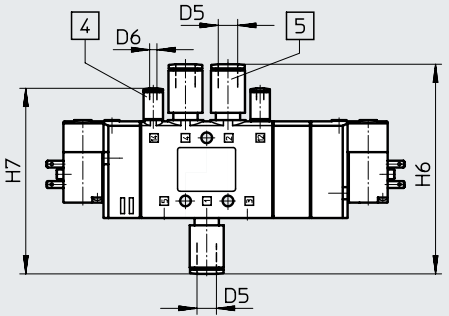

- [1] Manual override
- [2] Plug pins, plug pattern ZC
- [3] Space for inscription labels
- [4] Port 12/14 for external pilot air supply
- [5] QS push-in fitting

| Type              | B1 | B2 | B3  | B4  | D1   | D2 | D3 ø | D4 ø | D5 ø | D6 ø | H1   | H2 | H3 | H4   | H5   | H6   | H7   |
|-------------------|----|----|-----|-----|------|----|------|------|------|------|------|----|----|------|------|------|------|
| CPE14-M1BH...-5]  | 14 | 10 | 3.5 | 3.5 | G1/8 | M3 | 4.4  | 6    | 8    | 3    | 40.3 | 26 | 7  | 75.3 | 70.9 | 86.3 | 76.4 |
| CPE14-M1BH...-5/3 |    |    |     |     |      |    |      |      |      |      |      |    |    |      |      |      |      |

| Type              | L1  | L2  | L3 | L4   | L5   | L6 | L7  | L8   | L9 | L10  | L11  | L12 | L13 |
|-------------------|-----|-----|----|------|------|----|-----|------|----|------|------|-----|-----|
| CPE14-M1BH...-5]  | 118 | 85  | 46 | 18.3 | 17.5 | 27 | 9.5 | 44.5 | 32 | 18.3 | 17.5 | 5   | 20  |
| CPE14-M1BH...-5/3 | 134 | 101 |    |      |      |    |     |      |    |      |      |     |     |



Datasheet

Dimensions – Solenoid valves with round plug M8x1

Download CAD data → [www.festo.com](http://www.festo.com)

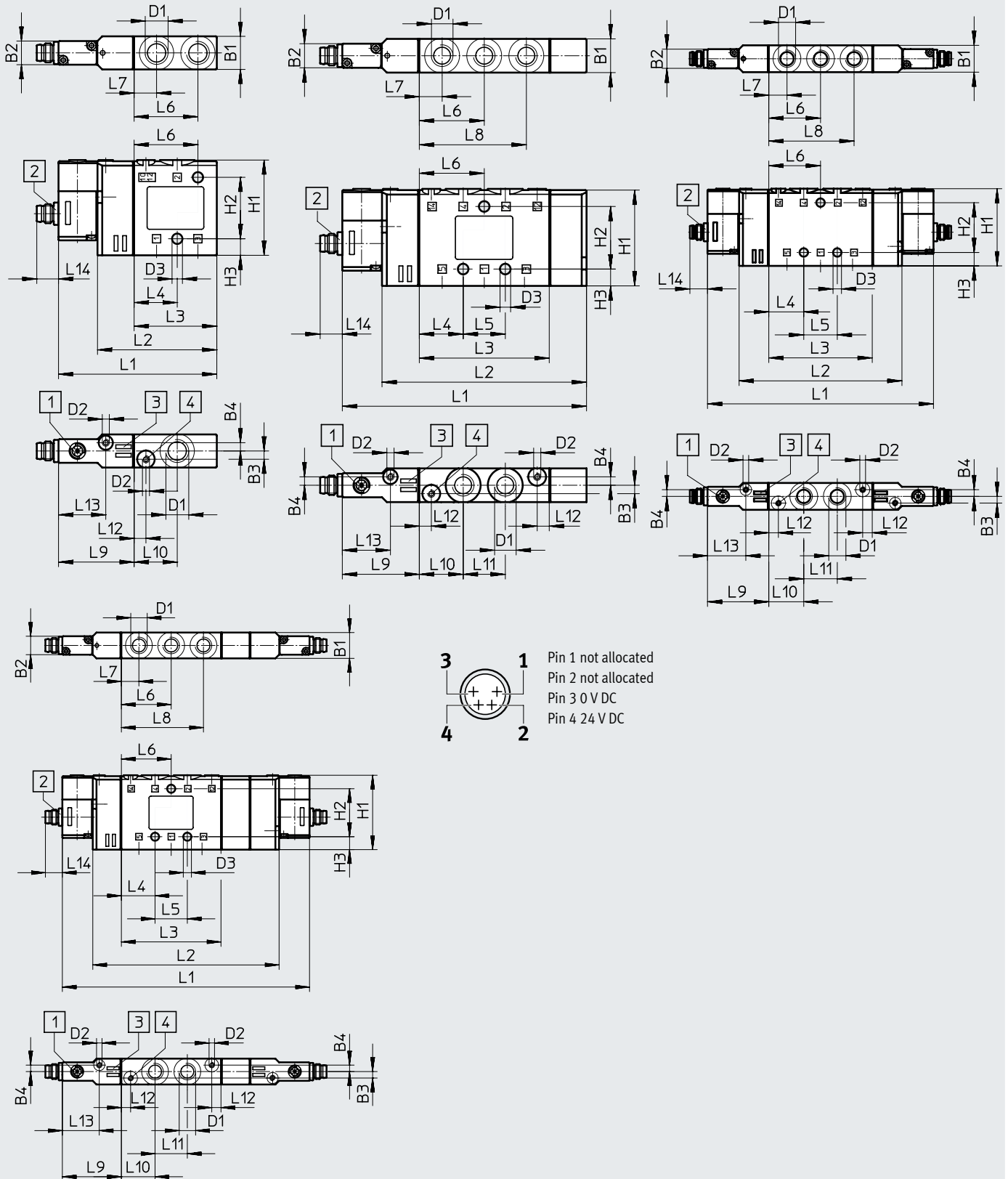

[1] Manual override

[2] Plug M8x1

[3] Space for inscription labels

[4] Port 12/14 for external pilot air

Datasheet

| Type             | B1 | B2 | B3  | B4  | D1   | D2 | D3<br>∅ | H1   | H2 | H3 |
|------------------|----|----|-----|-----|------|----|---------|------|----|----|
| CPE14-M1CH-3...  | 14 | 10 | 3.5 | 3.5 | G1/8 | M3 | 4.4     | 40.3 | 26 | 7  |
| CPE14-M1CH-5L... |    |    |     |     |      |    |         | 40.4 |    |    |
| CPE14-M1CH-5J... |    |    |     |     |      |    |         | 40.3 |    |    |
| CPE14-M1BH-5J    |    |    |     |     |      |    |         |      |    |    |
| CPE14-M1BH-5/3   |    |    |     |     |      |    |         |      |    |    |

| Type              | L1    | L2   | L3 | L4   | L5   | L6 | L7  | L8   | L9 | L10  | L11  | L12 | L13 | L14 |
|-------------------|-------|------|----|------|------|----|-----|------|----|------|------|-----|-----|-----|
| CPE14-M1CH-3...   | 67    | 50.5 | 35 | 18.3 | -    | 27 | 9.5 | -    | 32 | 18.3 | -    | 5   | 20  | 9.2 |
| CPE14-M1CH-5L...  | 101.5 | 85   | 54 |      | 17.5 |    |     | 44.5 |    |      | 17.5 |     |     |     |
| CPE14-M1CH-5J...  | 118   |      |    |      |      |    |     |      |    |      |      |     |     |     |
| CPE14-M1BH-5J...  |       |      |    |      |      |    |     |      |    |      |      |     |     |     |
| CPE14-M1BH-5/3... | 134   | 101  |    |      |      |    |     |      |    |      |      |     |     |     |

## Ordering data

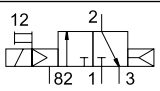
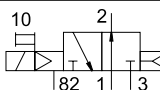
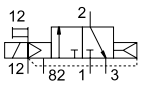
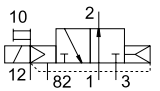
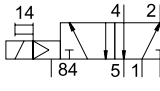
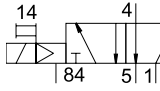
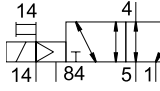
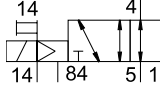
| Ordering data   |                  |                            |                   |                      |            |                      |                      |
|---|------------------|----------------------------|-------------------|----------------------|------------|----------------------|----------------------|
| Circuit symbol  | Pilot air supply | Electrical connection      | Operating voltage | Pneumatic connection | Weight [g] | Part no.             | Type                 |
| <b>3/2-way valve, normally closed</b>   |                  |                            |                   |                      |            |                      |                      |
|    | Internal         | Plug pins, plug pattern ZC | 24 V DC           | G1/8                 | 60         | 196929               | CPE14-M1BH-3GL-1/8   |
|   |                  |                            |                   | QS-6                 | –          | 196887               | CPE14-M1BH-3GL-QS-6  |
|   |                  | QS-8                       |                   | –                    | 196888     | CPE14-M1BH-3GL-QS-8  |                      |
|   |                  | Plug M8x1                  |                   | G1/8                 | 60         | 550247               | CPE14-M1CH-3GL-1/8   |
| <b>3/2-way valve, normally open</b>   |                  |                            |                   |                      |            |                      |                      |
|    | Internal         | Plug pins, plug pattern ZC | 24 V DC           | G1/8                 | 60         | 196931               | CPE14-M1BH-3OL-1/8   |
|   |                  |                            |                   | QS-6                 | –          | 196891               | CPE14-M1BH-3OL-QS-6  |
|   |                  | QS-8                       |                   | –                    | 196892     | CPE14-M1BH-3OL-QS-8  |                      |
|   |                  | Plug M8x1                  |                   | G1/8                 | 60         | 550249               | CPE14-M1CH-3OL-1/8   |
| <b>3/2-way valve, normally closed</b>   |                  |                            |                   |                      |            |                      |                      |
|    | External         | Plug pins, plug pattern ZC | 24 V DC           | G1/8                 | 60         | 196930               | CPE14-M1BH-3GLS-1/8  |
|   |                  |                            |                   | QS-6                 | –          | 196889               | CPE14-M1BH-3GLS-QS-6 |
|   |                  | QS-8                       |                   | –                    | 196890     | CPE14-M1BH-3GLS-QS-8 |                      |
|   |                  | Plug M8x1                  |                   | G1/8                 | 60         | 550248               | CPE14-M1CH-3GLS-1/8  |
| <b>3/2-way valve, normally open</b>   |                  |                            |                   |                      |            |                      |                      |
|    | External         | Plug pins, plug pattern ZC | 24 V DC           | G1/8                 | 60         | 196932               | CPE14-M1BH-3OLS-1/8  |
|   |                  |                            |                   | QS-6                 | –          | 196893               | CPE14-M1BH-3OLS-QS-6 |
|   |                  | QS-8                       |                   | –                    | 196894     | CPE14-M1BH-3OLS-QS-8 |                      |
|   |                  | Plug M8x1                  |                   | G1/8                 | 60         | 550250               | CPE14-M1CH-3OLS-1/8  |
| <b>5/2-way valve, single solenoid</b>   |                  |                            |                   |                      |            |                      |                      |
|  | Internal         | Plug pins, plug pattern ZC | 24 V DC           | G1/8                 | 95         | 196941               | CPE14-M1BH-5L-1/8    |
|   |                  |                            |                   | QS-6                 | –          | 196911               | CPE14-M1BH-5L-QS-6   |
|   |                  | QS-8                       |                   | –                    | 196912     | CPE14-M1BH-5L-QS-8   |                      |
|   |                  | Plug M8x1                  |                   | G1/8                 | 95         | 550237               | CPE14-M1CH-5L-1/8    |
| <b>5/2-way double pilot valve</b>   |                  |                            |                   |                      |            |                      |                      |
|  | Internal         | Plug pins, plug pattern ZC | 24 V DC           | G1/8                 | 115        | 196939               | CPE14-M1BH-5J-1/8    |
|   |                  |                            |                   | QS-6                 | –          | 196907               | CPE14-M1BH-5J-QS-6   |
|   |                  | QS-8                       |                   | –                    | 196908     | CPE14-M1BH-5J-QS-8   |                      |
|   |                  | Plug M8x1                  |                   | G1/8                 | 115        | 550239               | CPE14-M1CH-5J-1/8    |
| <b>5/2-way valve, single solenoid</b>   |                  |                            |                   |                      |            |                      |                      |
|  | External         | Plug pins, plug pattern ZC | 24 V DC           | G1/8                 | 95         | 196942               | CPE14-M1BH-5LS-1/8   |
|   |                  |                            |                   | QS-6                 | –          | 196913               | CPE14-M1BH-5LS-QS-6  |
|   |                  | QS-8                       |                   | –                    | 196914     | CPE14-M1BH-5LS-QS-8  |                      |
|   |                  | Plug M8x1                  |                   | G1/8                 | 95         | 550238               | CPE14-M1CH-5LS-1/8   |
| <b>5/2-way double pilot valve</b>   |                  |                            |                   |                      |            |                      |                      |
|  | External         | Plug pins, plug pattern ZC | 24 V DC           | G1/8                 | 115        | 196940               | CPE14-M1BH-5JS-1/8   |
|   |                  |                            |                   | QS-6                 | –          | 196909               | CPE14-M1BH-5JS-QS-6  |
|   |                  | QS-8                       |                   | –                    | 196910     | CPE14-M1BH-5JS-QS-8  |                      |
|   |                  | Plug M8x1                  |                   | G1/8                 | 115        | 550240               | CPE14-M1CH-5JS-1/8   |

## Ordering data

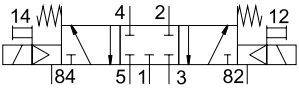
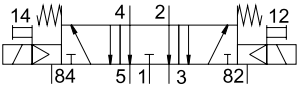
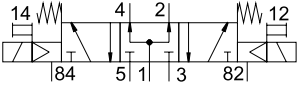
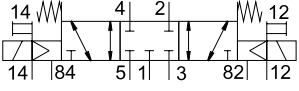
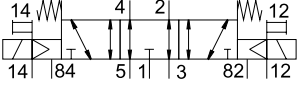
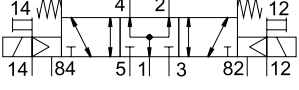
| Ordering data<br>Circuit symbol  | Pilot air supply | Electrical connection      | Operating voltage | Pneumatic connection | Weight<br>[g] | Part no.      | Type                  |
|--|------------------|----------------------------|-------------------|----------------------|---------------|---------------|-----------------------|
| <b>5/3-way mid-position valve, normally closed</b>                                 |                  |                            |                   |                      |               |               |                       |
|    | Internal         | Plug pins, plug pattern ZC | 24 V DC           | G1/8                 | 120           | <b>196937</b> | CPE14-M1BH-5/3G-1/8   |
|  |                  |                            |                   | QS-6                 | –             | <b>196903</b> | CPE14-M1BH-5/3G-QS-6  |
|  |                  |                            |                   | QS-8                 | –             | <b>196904</b> | CPE14-M1BH-5/3G-QS-8  |
|  |                  |                            |                   | Plug M8x1            | G1/8          | 120           | <b>550241</b>         |
| <b>5/3-way mid-position valve, normally exhausted</b>                              |                  |                            |                   |                      |               |               |                       |
|    | Internal         | Plug pins, plug pattern ZC | 24 V DC           | G1/8                 | 120           | <b>196935</b> | CPE14-M1BH-5/3E-1/8   |
|  |                  |                            |                   | QS-6                 | –             | <b>196899</b> | CPE14-M1BH-5/3E-QS-6  |
|  |                  |                            |                   | QS-8                 | –             | <b>196900</b> | CPE14-M1BH-5/3E-QS-8  |
|  |                  |                            |                   | Plug M8x1            | G1/8          | 120           | <b>550243</b>         |
| <b>5/3-way mid-position valve, normally open</b>                                   |                  |                            |                   |                      |               |               |                       |
|    | Internal         | Plug pins, plug pattern ZC | 24 V DC           | G1/8                 | 120           | <b>196933</b> | CPE14-M1BH-5/3B-1/8   |
|  |                  |                            |                   | QS-6                 | –             | <b>196895</b> | CPE14-M1BH-5/3B-QS-6  |
|  |                  |                            |                   | QS-8                 | –             | <b>196896</b> | CPE14-M1BH-5/3B-QS-8  |
|  |                  |                            |                   | Plug M8x1            | G1/8          | 120           | <b>550245</b>         |
| <b>5/3-way mid-position valve, normally closed</b>                                 |                  |                            |                   |                      |               |               |                       |
|    | External         | Plug pins, plug pattern ZC | 24 V DC           | G1/8                 | 120           | <b>196938</b> | CPE14-M1BH-5/3GS-1/8  |
|  |                  |                            |                   | QS-6                 | –             | <b>196905</b> | CPE14-M1BH-5/3GS-QS-6 |
|  |                  |                            |                   | QS-8                 | –             | <b>196906</b> | CPE14-M1BH-5/3GS-QS-8 |
|  |                  |                            |                   | Plug M8x1            | G1/8          | 120           | <b>550242</b>         |
| <b>5/3-way mid-position valve, normally exhausted</b>                              |                  |                            |                   |                      |               |               |                       |
|  | External         | Plug pins, plug pattern ZC | 24 V DC           | G1/8                 | 120           | <b>196936</b> | CPE14-M1BH-5/3ES-1/8  |
|  |                  |                            |                   | QS-6                 | –             | <b>196901</b> | CPE14-M1BH-5/3ES-QS-6 |
|  |                  |                            |                   | QS-8                 | –             | <b>196902</b> | CPE14-M1BH-5/3ES-QS-8 |
|  |                  |                            |                   | Plug M8x1            | G1/8          | 120           | <b>550244</b>         |
| <b>5/3-way mid-position valve, normally open</b>                                   |                  |                            |                   |                      |               |               |                       |
|  | External         | Plug pins, plug pattern ZC | 24 V DC           | G1/8                 | 120           | <b>196934</b> | CPE14-M1BH-5/3BS-1/8  |
|  |                  |                            |                   | QS-6                 | –             | <b>196897</b> | CPE14-M1BH-5/3BS-QS-6 |
|  |                  |                            |                   | QS-8                 | –             | <b>196898</b> | CPE14-M1BH-5/3BS-QS-8 |
|  |                  |                            |                   | Plug M8x1            | G1/8          | 120           | <b>550246</b>         |

# Datasheet – Manifold block

## Manifold block CPE...-PRS

Material:  
Wrought aluminium alloy  
RoHS-compliant



### Dimensions – Fixed-grid manifold 5/2 and 5/3

Download CAD data → [www.festo.com](http://www.festo.com)

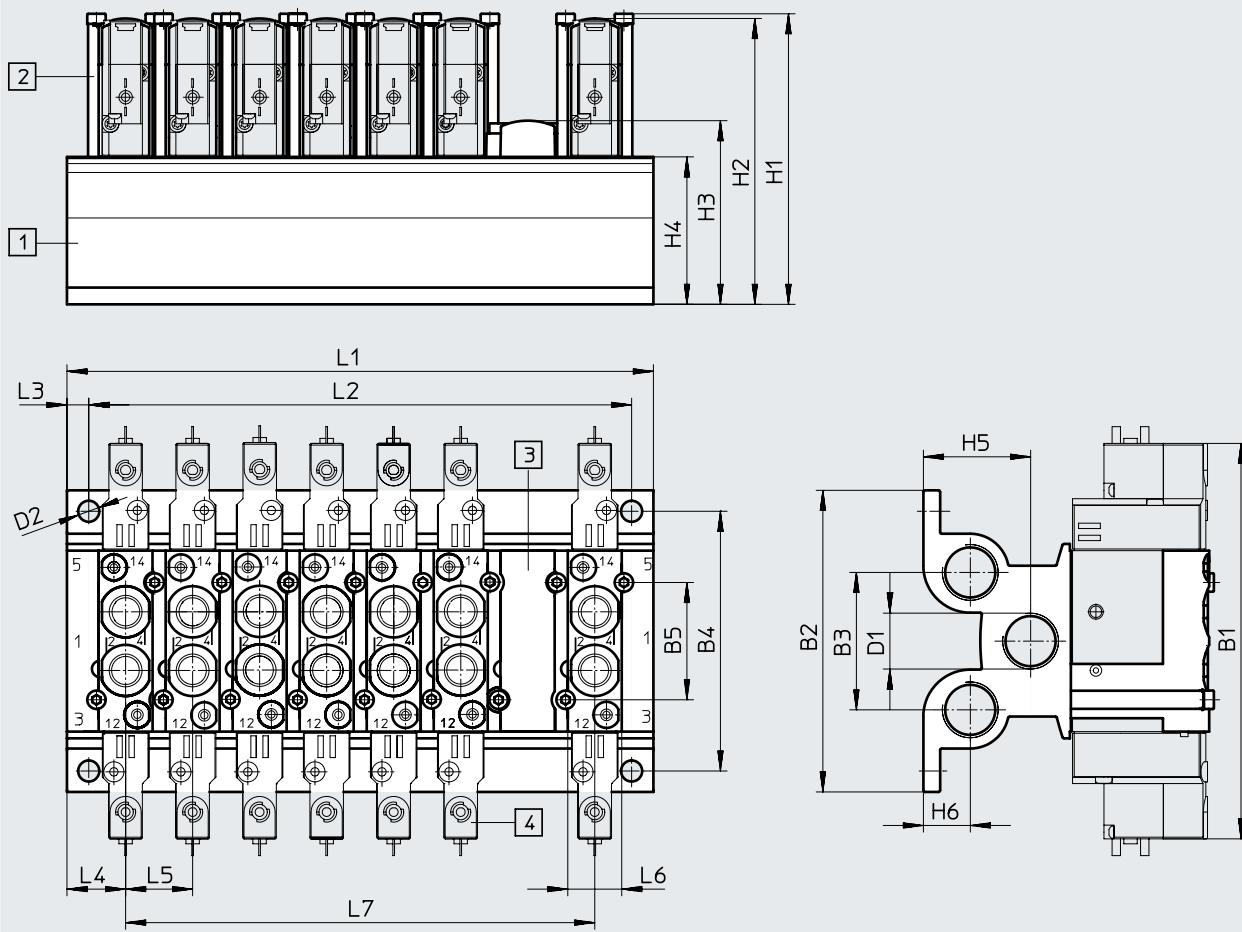

[1] Manifold block  
Grid dimension 16 mm

[2] Retaining bracket

[3] Cover plate

[4] Valves

| Type         | B1  | B2 | B3 | B4   | B5 | D1   | D2  | H1   | H2   | H3   | H4 | H5 | H6 |
|--------------|-----|----|----|------|----|------|-----|------|------|------|----|----|----|
| CPE14-PRS... | 118 | 90 | 41 | 77.5 | 35 | G3/8 | 6.3 | 86.7 | 84.8 | 54.8 | 44 | 32 | 14 |

| Type         | L1              | L2            | L3  | L4   | L5 | L6   | L7         |
|--------------|-----------------|---------------|-----|------|----|------|------------|
| CPE14-PRS... | 35 + (n-1) x 20 | L1 - 13 ± 0.1 | 6.5 | 17.5 | 20 | 17.4 | (n-1) x 20 |

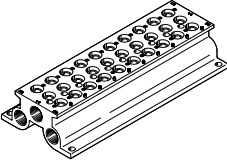

## Ordering data – Fixed-grid manifold block

| Ordering data  | Valve positions | CRC <sup>1)</sup> | Max. tightening torque [Nm] | Weight [g] | Part no. | Type             |
|--|-----------------|-------------------|-----------------------------|------------|----------|------------------|
| <b>Manifold block for 5/2- and 5/3-way valves</b>                                |                 |                   |                             |            |          |                  |
|  | 2               | 2                 | 1.2                         | 239        | 543830   | CPE14-PRS-3/8-2  |
|  | 3               |                   |                             | 326        | 543831   | CPE14-PRS-3/8-3  |
|  | 4               |                   |                             | 412        | 543832   | CPE14-PRS-3/8-4  |
|  | 5               |                   |                             | 498        | 543833   | CPE14-PRS-3/8-5  |
|  | 6               |                   |                             | 584        | 543834   | CPE14-PRS-3/8-6  |
|  | 7               |                   |                             | 671        | 543835   | CPE14-PRS-3/8-7  |
|  | 8               |                   |                             | 757        | 543836   | CPE14-PRS-3/8-8  |
|  | 9               |                   |                             | 843        | 543837   | CPE14-PRS-3/8-9  |
|  | 10              |                   |                             | 930        | 543838   | CPE14-PRS-3/8-10 |

1) Corrosion resistance class CRC 2 to Festo standard FN 940070

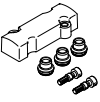
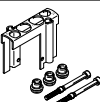
Moderate corrosion stress. Indoor applications in which condensation can occur. External visible parts with primarily decorative surface requirements which are in direct contact with a normal industrial environment.

| Ordering data   | Material  | Part no. | Type         |
|---|---|----------|--------------|
| <b>Cover plate for vacant position</b>  |   |          |              |
|   | PA  | 544480   | CPE14-RP     |
| <b>Retaining bracket set</b>  |   |          |              |
|  | Retaining bracket: high-alloy stainless steel<br>Screws: galvanised steel<br>Seals: NBR | 544395   | CPE14-H5-SET |

| Ordering data  | Material  | Part no. | Type               |
|--|---|----------|--------------------|
| <b>Retaining bracket</b>   |   |          |                    |
|  | Retaining bracket: high-alloy stainless steel<br>(packaging unit 50 pieces) | 547046   | CPE14-H5-50        |
| <b>Screws</b>  |   |          |                    |
|  | Galvanised steel<br>(packaging unit 100 pieces)                             | 547049   | M3X45-8.8-VS-100   |
| <b>Seals</b>   |   |          |                    |
|  | NBR<br>(packaging unit 150 pieces)  | 547052   | CPV14-VI-P.1/8-150 |

## Technical data – Fixed-grid manifold block

### Manifold block

For CPE14 3/2

### Material:

Wrought aluminium alloy

RoHS-compliant

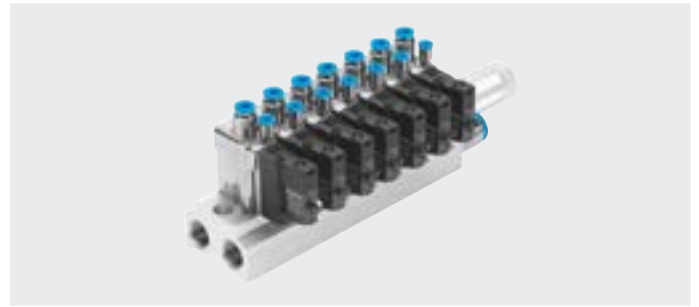

### Dimensions for fixed-grid manifold 3/2

Download CAD data → [www.festo.com](http://www.festo.com)

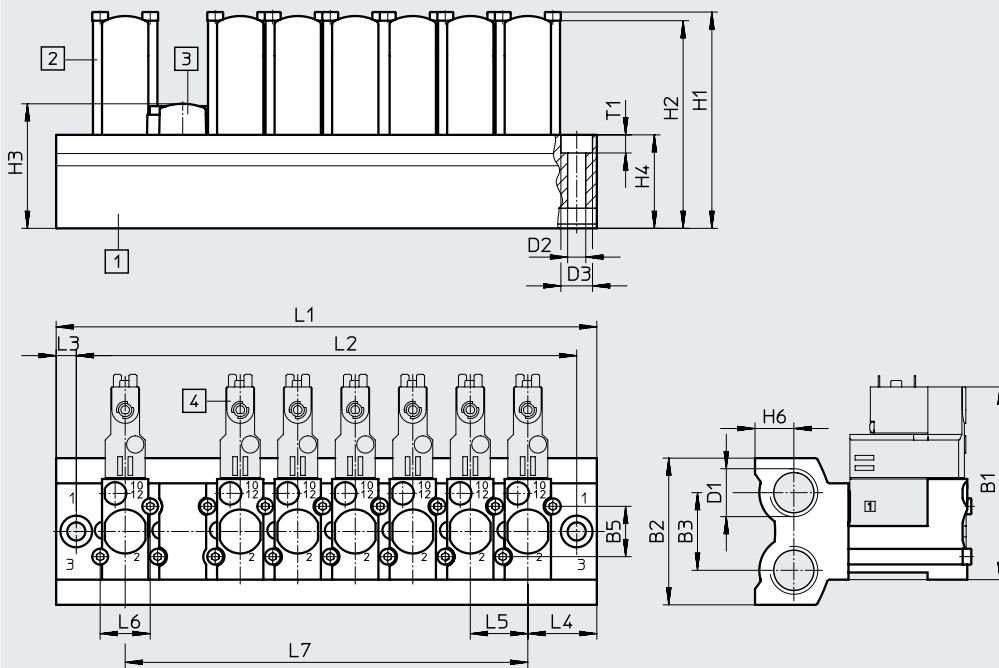

- [1] Manifold block
  - [2] Retaining bracket
  - [3] Cover plate
  - [4] Valves
- Grid dimension 20 mm

| Type             | B1 | B2 | B3 | B5   | D1   | D2  | D3 | H1   | H2   | H3   | H4   | H6   |
|------------------|----|----|----|------|------|-----|----|------|------|------|------|------|
| CPE14-3/2-PRS... | 67 | 51 | 27 | 17.5 | G3/8 | 6.3 | 11 | 75.2 | 72.2 | 43.3 | 32.5 | 13.5 |

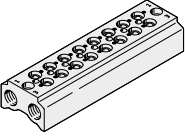

| Type             | L1                     | L2                     | L3 | L4 | L5 | L6   | L7                | T1  |
|------------------|------------------------|------------------------|----|----|----|------|-------------------|-----|
| CPE14-3/2-PRS... | $48 + (n-1) \times 20$ | $34 + (n-1) \times 20$ | 7  | 24 | 20 | 17.4 | $(n-1) \times 20$ | 6.3 |

## Ordering data – Fixed-grid manifold block

| Ordering data  |    | Valve positions | CRC <sup>1)</sup> | Max. tightening torque for valve mounting [Nm] | Weight [g] | Part no. | Type                 |
|--|----|-----------------|-------------------|--|------------|----------|----------------------|
| <b>Manifold block for 3/2-way valves</b>   |    |                 |                   |  |            |          |                      |
|  | 2  | 2               | 1.2               |  | 176        | 550559   | CPE14-3/2-PRS-3/8-2  |
|  | 3  |                 |                   |  | 228        | 550560   | CPE14-3/2-PRS-3/8-3  |
|  | 4  |                 |                   |  | 280        | 550561   | CPE14-3/2-PRS-3/8-4  |
|  | 5  |                 |                   |  | 332        | 550562   | CPE14-3/2-PRS-3/8-5  |
|  | 6  |                 |                   |  | 384        | 550563   | CPE14-3/2-PRS-3/8-6  |
|  | 7  |                 |                   |  | 436        | 550564   | CPE14-3/2-PRS-3/8-7  |
|  | 8  |                 |                   |  | 488        | 550565   | CPE14-3/2-PRS-3/8-8  |
|  | 9  |                 |                   |  | 540        | 550566   | CPE14-3/2-PRS-3/8-9  |
|  | 10 |                 |                   |  | 592        | 550567   | CPE14-3/2-PRS-3/8-10 |

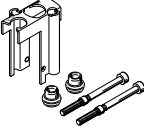
1) Corrosion resistance class CRC 2 to Festo standard FN 940070  
 Moderate corrosion stress. Indoor applications in which condensation can occur. External visible parts with primarily decorative surface requirements which are in direct contact with a normal industrial environment.

| Ordering data  |  | Material  | Part no. | Type         |
|--|--|---|----------|--------------|
| <b>Cover plate</b>   |  |   |          |              |
|    |  | PA  | 550581   | CPE14-RP3    |
| <b>Retaining bracket set</b>   |  |   |          |              |
|  |  | Retaining bracket: high-alloy stainless steel<br>Screws: galvanised steel<br>Seals: NBR | 550578   | CPE14-H3-SET |

| Ordering data  |  | Material  | Part no. | Type               |
|--|--|---|----------|--------------------|
| <b>Retaining bracket</b>   |  |   |          |                    |
|  |  | Retaining bracket: high-alloy stainless steel<br>(packaging unit 50 pieces) | 551491   | CPE14-H3-50        |
| <b>Screws</b>  |  |   |          |                    |
|  |  | Galvanised steel<br>(packaging unit 100 pieces)                             | 547049   | M3X45-8.8-VS-100   |
| <b>Seals</b>   |  |   |          |                    |
|  |  | NBR<br>(packaging unit 150 pieces)  | 547052   | CPV14-VI-P.1/8-150 |



## Technical data – Modular manifold

### Modular manifold block

For CPE14 5/2 and 5/3

Material:  
Reinforced PA

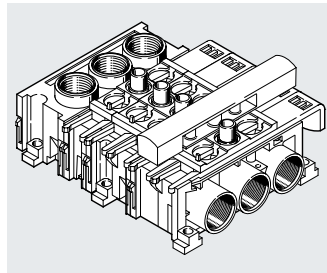

### Dimensions – Modular manifold block

Download CAD data → [www.festo.com](http://www.festo.com)

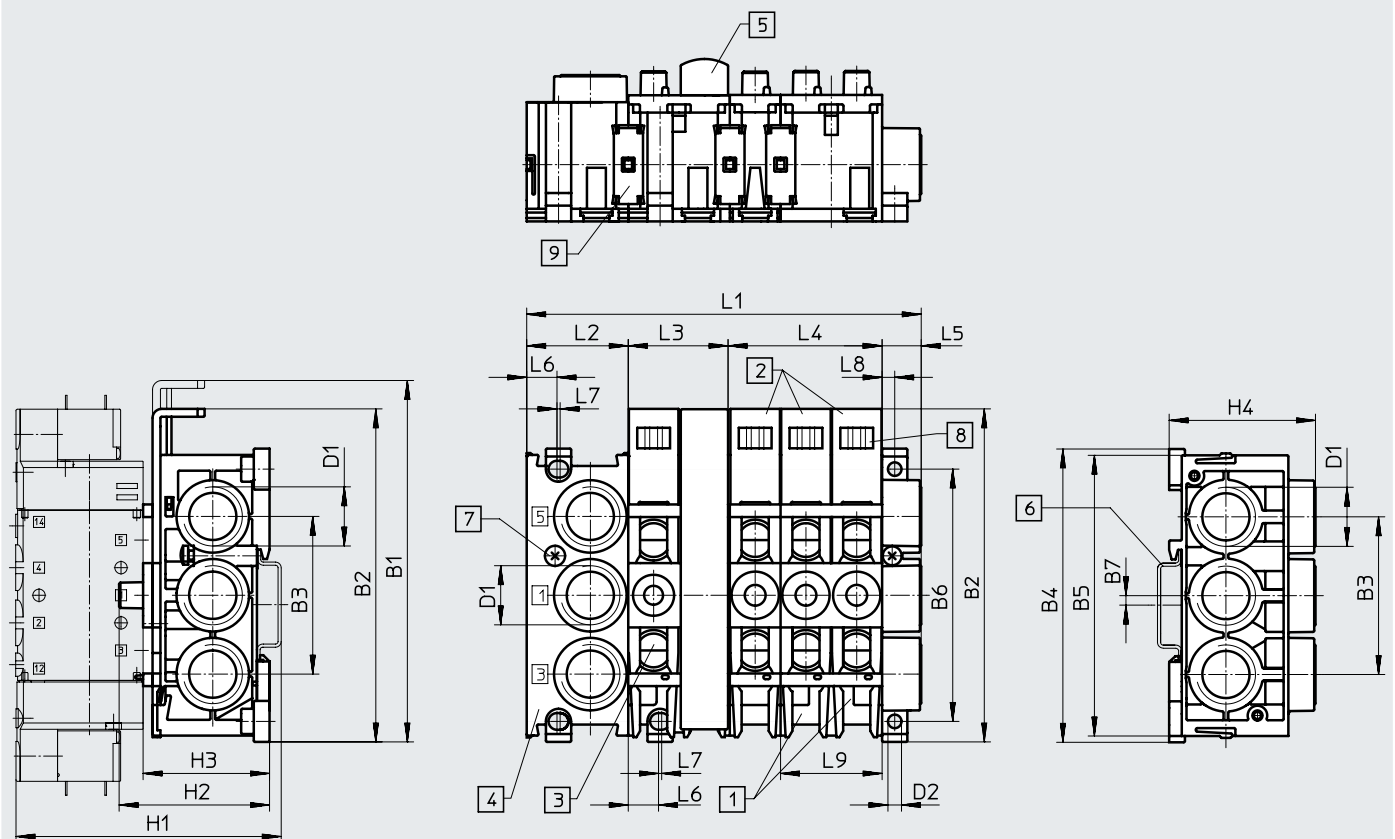

- [1] Manifold block  
CPE...-PRSG...-2 for  
2 valves
- [2] Manifold block  
CPE...-PRSG...-3 for  
3 valves
- [3] Expansion block  
CPE...-PRSE...-2 for 2 valves
- [4] End block CPE...-PRS-EP
- [5] Cover plate CPE...-PRSB
- [6] H-rail to EN 50002 for mounting
- [7] Clamping screw for H-rail
- [8] Location for inscription label  
type IBS 6 x 10
- [9] Connecting component

| Size  | B1    | B2    | B3 | B4 | B5 | B6 | B7 | D1   | D2<br>∅ | H1  | H2  | H3  | H4   |
|-------|-------|-------|----|----|----|----|----|------|---------|-----|-----|-----|------|
| CPE14 | 114.6 | 105.6 | 50 | 93 | 89 | 80 | 3  | G3/8 | 4.3     | ~84 | ~48 | ~40 | 46.4 |

| Size  | L1 <sup>1)</sup> |  |  | L2 | L3 | L4 | L5   | L6   | L7 | L8 | L9 |
|-------|------------------|--|--|----|----|----|------|------|----|----|----|
| CPE14 | 32+(n×16)+12.4   |  |  | 32 | 32 | 48 | 12.4 | 10.1 | -  | 4  | 32 |

1) n = number of valve positions

### Technical data – Modular manifold

| Combination options<br>Number of valve positions | One pressure zone  | Two pressure zones  |  |
|--|--|---|--|
|  |  | Variant 1   | Variant 2  |
| 2  | 1x CPE...-PRSG-2   | –   | –  |
| 3  | 1x CPE...-PRSG-3   | –   | –  |
| 4  | 1x CPE...-PRSGO-2<br>1x CPE...-PRSE-2                      | 1x CPE...-PRSG-2<br>1x CPE...-PRSEO-2<br>1x CPE...-PRS-EP | –  |
| 5  | 1x CPE...-PRSGO-3<br>1x CPE...-PRSE-2                      | 1x CPE...-PRSG-3<br>1x CPE...-PRSEO-2<br>1x CPE...-PRS-EP | –  |
| 6  | 1x CPE...-PRSGO-2<br>1x CPE...-PRSEO-2<br>1x CPE...-PRSE-2 | 1x CPE...-PRSG-2<br>2x CPE...-PRSEO-2<br>1x CPE...-PRS-EP | 1x CPE...-PRSGO-2<br>1x CPE...-PRSE-2<br>1x CPE...-PRSEO-2<br>1x CPE...-PRS-EP |
| 7  | 1x CPE...-PRSGO-3<br>2x CPE...-PRSEO-2<br>1x CPE...-PRS-EP | 1x CPE...-PRSG-3<br>2x CPE...-PRSEO-2<br>1x CPE...-PRS-EP | 1x CPE...-PRSGO-3<br>1x CPE...-PRSE-2<br>1x CPE...-PRSEO-2<br>1x CPE...-PRS-EP |
| 8  | 1x CPE...-PRSGO-2<br>3x CPE...-PRSEO-2<br>1x CPE...-PRS-EP | 1x CPE...-PRSG-2<br>3x CPE...-PRSEO-2<br>1x CPE...-PRS-EP | 1x CPE...-PRSGO-2<br>1x CPE...-PRSE-2<br>2x CPE...-PRSEO-2<br>1x CPE...-PRS-EP |
| 9  | 1x CPE...-PRSGO-3<br>3x CPE...-PRSEO-2<br>1x CPE...-PRS-EP | 1x CPE...-PRSG-3<br>3x CPE...-PRSEO-2<br>1x CPE...-PRS-EP | 1x CPE...-PRSGO-3<br>1x CPE...-PRSE-2<br>2x CPE...-PRSEO-2<br>1x CPE...-PRS-EP |
| 10   | 1x CPE...-PRSGO-2<br>4x CPE...-PRSEO-2<br>1x CPE...-PRS-EP | 1x CPE...-PRSG-2<br>4x CPE...-PRSEO-2<br>1x CPE...-PRS-EP | 1x CPE...-PRSGO-2<br>1x CPE...-PRSE-2<br>3x CPE...-PRSEO-2<br>1x CPE...-PRS-EP |
| 11   | 1x CPE...-PRSGO-3<br>4x CPE...-PRSEO-2<br>1x CPE...-PRS-EP | 1x CPE...-PRSG-3<br>4x CPE...-PRSEO-2<br>1x CPE...-PRS-EP | 1x CPE...-PRSGO-3<br>1x CPE...-PRSE-2<br>3x CPE...-PRSEO-2<br>1x CPE...-PRS-EP |
| 12   | 1x CPE...-PRSGO-2<br>5x CPE...-PRSEO-2<br>1x CPE...-PRS-EP | 1x CPE...-PRSG-2<br>5x CPE...-PRSEO-2<br>1x CPE...-PRS-EP | 1x CPE...-PRSGO-2<br>1x CPE...-PRSE-2<br>4x CPE...-PRSEO-2<br>1x CPE...-PRS-EP |

 - **Note**

Each air supply can support a maximum of 6 valve positions. Use valve manifold blocks only in combination with 5/2- and 5/3-way valves.

Ordering data – Modular manifold

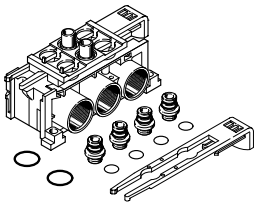
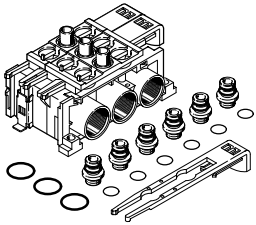
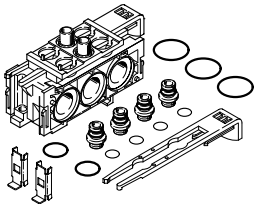
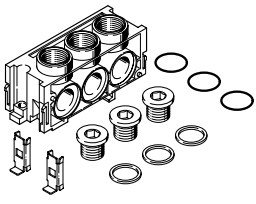
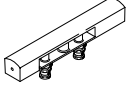
| Ordering data   | Port 1, 3, 5 | PRS ducts | Weight [g] | Part no.      | Type                 |
|---|--------------|-----------|------------|---------------|----------------------|
| <b>Manifold block PRSG for 2 valves</b>   |              |           |            |               |                      |
|    | G3/8         | Closed    | 95         | <b>164965</b> | <b>CPE14-PRSG-2</b>  |
|   | G3/8         | Open      | 95         | <b>187829</b> | <b>CPE14-PRSGO-2</b> |
| <b>Manifold block PRSG for 3 valves</b>   |              |           |            |               |                      |
|    | G3/8         | Closed    | 130        | <b>187824</b> | <b>CPE14-PRSG-3</b>  |
|   | G3/8         | Open      | 130        | <b>187820</b> | <b>CPE14-PRSGO-3</b> |
| <b>Manifold block PRSE for 2 valves</b>   |              |           |            |               |                      |
|   | –            | Closed    | 85         | <b>164967</b> | <b>CPE14-PRSE-2</b>  |
|   | –            | Open      | 85         | <b>187830</b> | <b>CPE14-PRSEO-2</b> |
| <b>End plate for manifold</b>   |              |           |            |               |                      |
|  | G3/8         | –         | 80         | <b>164969</b> | <b>CPE14-PRS-EP</b>  |
| <b>Cover plate for vacant position</b>  |              |           |            |               |                      |
|  | –            | –         | 15         | <b>164968</b> | <b>CPE14-PRSB</b>    |

## Type codes

| 001 | Series                              |
|-----|-------------------------------------|
| CPE | Solenoid valve, Compact Performance |

| 002 | Width |
|-----|-------|
| 18  | 18 mm |

| 003 | Nominal operating voltage |
|-----|---------------------------|
|     | None                      |
| M1  | 24 V DC                   |
| M2  | 110 V AC                  |
| M3  | 230 V AC                  |

| 004 | Electrical connection                                     |
|-----|---|
| H   | Plug pattern ZC   |
| P1  | Interface for pilot valve size 15 mm to ISO 15218 (CNOMO) |

| 005  | Valve function                          |
|------|---|
| 5L   | 5/2-way valve, monostable               |
| 5J   | 5/2-way valve, bistable                 |
| 3GL  | 3/2-way valve, normally closed          |
| 3OL  | 3/2-way valve, normally open            |
| 5/3G | 5/3-way valve, mid-position closed      |
| 5/3E | 5/3-way valve, mid-position exhausted   |
| 5/3B | 5/3-way valve, mid-position pressurised |

| 006 | Pilot air |
|-----|-----------|
|     | Internal  |
| S   | External  |

  

| 007   | Pneumatic connection    |
|-------|-------------------------|
| 1/4   | G1/4                    |
| QS-8  | Push-in connector 8 mm  |
| QS-10 | Push-in connector 10 mm |



## Datasheet

### Functions:

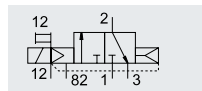
3/2G, 3/2O,  
5/2-way single solenoid  
5/2-way double pilot valve  
5/3G, 5/3B, 5/3E



3/2G with external pilot air supply,  
normally closed

-  - Width 18 mm
-  - Flow rate  
850 ... 1500 l/min
-  - Voltage for  
complete valves  
24 V DC, 110, 230 V AC  
Basic valves  
12, 24 V DC, 24, 110,  
230 V AC

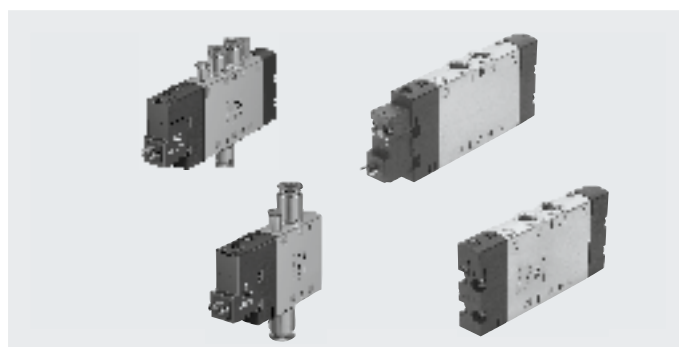

| General technical data                                     |         |         | 3/2  |                 | 5/2                        |   | 5/3             |                 |                            |      |
|--|---------|---------|--|-----------------|----------------------------|---|-----------------|-----------------|----------------------------|------|
| Valve function   |         |         | G <sup>1)</sup>  | O <sup>2)</sup> | -                          | -   | G <sup>1)</sup> | B <sup>2)</sup> | E <sup>3)</sup>            |      |
| Normal position  |         |         | Monostable   |                 |                            | Bistable                                  |                 | Monostable      |                            |      |
| Stable position  |         |         | Yes  |                 |                            | -   |                 | No              |                            |      |
| Pneumatic spring reset                                     |         |         | No   |                 |                            | -   |                 | Yes             |                            |      |
| Mechanical spring reset                                    |         |         | Piston spool   |                 |                            |   |                 |                 |                            |      |
| Design   |         |         | Soft   |                 |                            |   |                 |                 |                            |      |
| Sealing principle  |         |         | Positive overlap   |                 |                            |   |                 |                 |                            |      |
| Overlap  |         |         | Electrical   |                 |                            |   |                 |                 |                            |      |
| Actuation type   |         |         | Piloted  |                 |                            |   |                 |                 |                            |      |
| Type of control  |         |         | To ISO 15218 or none for integrated pilot valve          |                 |                            |   |                 |                 |                            |      |
| Pilot interface  |         |         | Internal or external                                     |                 |                            |   |                 |                 |                            |      |
| Pilot air supply   |         |         | -  |                 |                            | Reversible with external pilot air supply |                 |                 |                            |      |
| Flow direction   |         |         | -  |                 |                            | Can be throttled                          |                 |                 |                            |      |
| Exhaust function   |         |         | Non-detenting, detenting via accessory                   |                 |                            |   |                 |                 |                            |      |
| Manual override  |         |         | Via through-holes  |                 |                            |   |                 |                 |                            |      |
| Type of mounting   |         |         | Any  |                 |                            |   |                 |                 |                            |      |
| Mounting position  |         |         | Threaded connection: G1/4, QS connection: Ø 8 or Ø 10 mm |                 |                            |   |                 |                 |                            |      |
| Pneumatic connection                                       | 1, 2, 4 |         | Threaded connection: G1/4                                |                 |                            |   |                 |                 |                            |      |
|  | 3, 5    |         | Threaded connection: M5, QS connection: Ø 4 mm           |                 |                            |   |                 |                 |                            |      |
|  | 12, 14  |         | Threaded connection: M5                                  |                 |                            |   |                 |                 |                            |      |
|  | 82, 84  |         |  |                 |                            |   |                 |                 |                            |      |
| Nominal width  | [mm]    | 8       |  |                 |                            |   |                 |                 |                            |      |
| Standard nominal flow rate                                 | G1/4    | [l/min] | 1300   |                 | 1300                       |   | 1450            |                 | 1200 1300                  |      |
|  | QS8     | [l/min] | 850  |                 |                            |   |                 |                 | 780                        |      |
|  | QS10    | [l/min] | 1000   |                 |                            |   |                 | 1050            |                            | 1000 |
| Switching time   | On/Off  | [ms]    | 28/18, 36/30 <sup>5)</sup>                               |                 | 26/20, 32/30 <sup>5)</sup> |   | -               |                 | 20/38, 20/34 <sup>5)</sup> |      |
|  | Reverse | [ms]    | -  |                 |                            | 13, 15 <sup>5)</sup>                      |                 | -               |                            |      |
| Duty cycle   | [%]     | 100     |  |                 |                            |   |                 |                 |                            |      |
| Width  | [mm]    | 18      |  |                 |                            |   |                 |                 |                            |      |
| Conforms to standard                                       |         |         | ISO 15218 in the case of interface with pilot valve      |                 |                            |   |                 |                 |                            |      |
| Corrosion resistance class CRC <sup>4)</sup>               |         |         | 2  |                 |                            |   |                 |                 |                            |      |
| CE marking (see declaration of conformity) <sup>6)</sup>   |         |         | To EU Low Voltage Directive <sup>7)</sup>                |                 |                            |   |                 |                 |                            |      |
| UKCA marking (see declaration of conformity) <sup>6)</sup> |         |         | To UK regulations for electrical equipment <sup>7)</sup> |                 |                            |   |                 |                 |                            |      |

1) G = normally closed

2) O, B = normally open

3) E = normally exhausted

4) Corrosion resistance class CRC 2 to Festo standard FN 940070

Moderate corrosion stress. Indoor applications in which condensation can occur. External visible parts with primarily decorative surface requirements which are in direct contact with a normal industrial environment.

5) Switching time for basic valve

6) For information about the area of use, see the EC declaration of conformity at: [www.festo.com/catalogue/...](http://www.festo.com/catalogue/...) → Support/Downloads.

If the devices are subject to usage restrictions in residential, commercial or light-industrial environments, further measures for the reduction of the emitted interference may be necessary.

7) Only for CPE18-M2H... and CPE18-M3H...

## Datasheet

| Operating and environmental conditions |  |       |   |
|--|--|-------|---|
| Valve function                         |  | 3/2   | 5/2-way, single solenoid   5/2-way, double solenoid   5/3 |
| Operating medium                       | Compressed air to ISO 8573-1:2010 [7:4:4]  |       |   |
| Pilot medium                           | Compressed air to ISO 8573-1:2010 [7:4:4]  |       |   |
| Note on the operating/pilot medium     | Lubricated operation possible (in which case lubricated operation will always be required) |       |   |
| Operating pressure                     | Internal pilot air supply  | [bar] | 2.5 ... 10  |
|  | External pilot air supply  | [MPa] | -0.09 ... 1   |
|  |  | [bar] | -0.9 ... 10   |
| Pilot pressure                         |  | [MPa] | 0.25 ... 1  |
|  |  | [bar] | 2.5 ... 10  |
| Ambient temperature                    |  | [°C]  | -5 ... +50  |
| Temperature of medium                  |  | [°C]  | -5 ... +50  |
| Certification for solenoid valves      | c UL us - Recognized (OL) (not with CPE18-P1-...)  |       |   |
| Maritime classification <sup>1)</sup>  | See certificate  |       |   |

1) Additional information: [www.festo.com/sp](http://www.festo.com/sp) → Certificates.

| Electrical data                       |                   |        |                            |
|---------------------------------------|-------------------|--------|----------------------------|
| Operating voltage                     | M1H               | [V DC] | 24 +10/-15%                |
|                                       | M2H               | [V AC] | 110 ±10% with 50 ... 60 Hz |
|                                       | M3H               | [V AC] | 230 ±10% with 50 ... 60 Hz |
| Power consumption                     | M1H               | [W]    | 1.5                        |
|                                       | M2H, M3H          | [VA]   | Pull: 3, hold: 2.4         |
| Degree of protection with plug socket | IP65 to IEC 60529 |        |                            |

## Materials

Sectional view

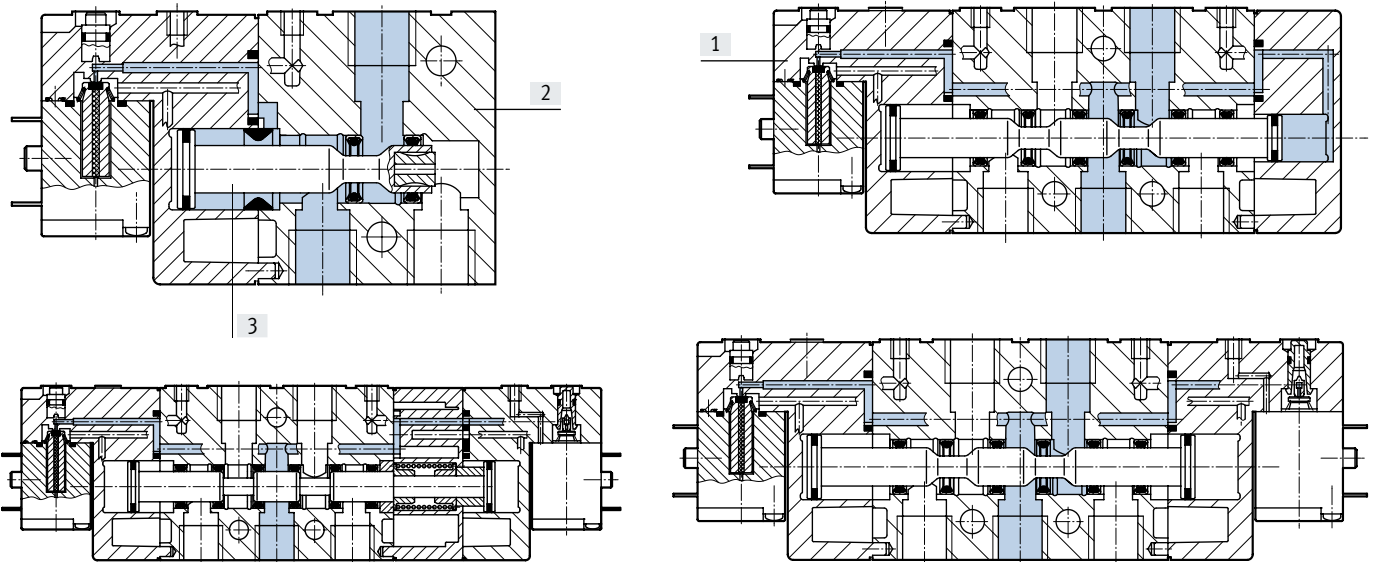

|                   |                    |
|-------------------|--------------------|
| [1] Cover         | PA                 |
| [2] Housing       | Die-cast aluminium |
| [3] Piston spool  | Steel              |
| - Seals           | NBR                |
| Note on materials | RoHS-compliant     |

Datasheet

Dimensions – 3/2-way valve

Download CAD data → [www.festo.com](http://www.festo.com)

CPE18-...-1/4

CPE18-...-QS-8

CPE18-...-QS-10

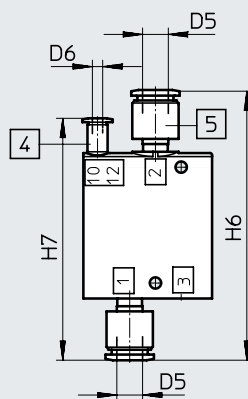
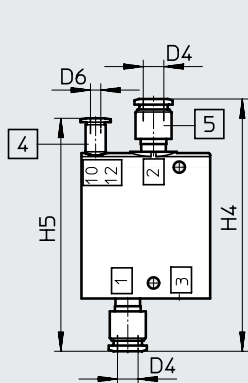
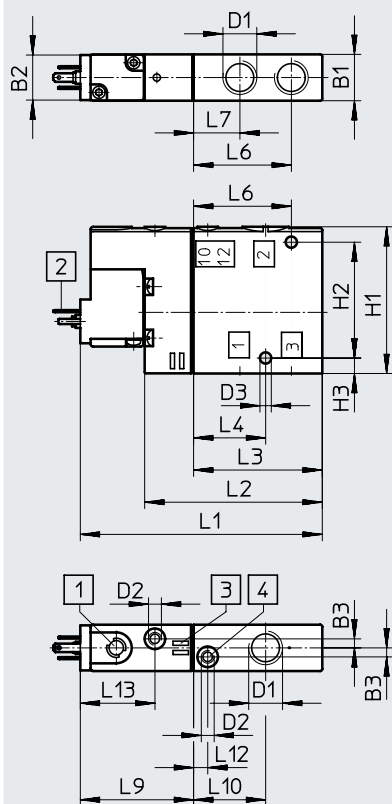

- [1] Manual override
- [2] Plug type C, to EN 175301-803
- [3] Space for inscription labels
- [4] Port 10/12 for external pilot air supply
- [5] QS push-in fitting

| Type           | B1 | B2   | B3  | D1   | D2 | D3<br>∅ | D4<br>∅ | D5<br>∅ | D6<br>∅ | H1 | H2 | H3 | H4 | H5   | H6  | H7 |
|----------------|----|------|-----|------|----|---------|---------|---------|---------|----|----|----|----|------|-----|----|
| CPE18-M1H-3... | 18 | 17.5 | 3.5 | G1/4 | M5 | 4.4     | 8       | 10      | 4       | 57 | 45 | 6  | 98 | 90.5 | 105 | 94 |

| Type           | L1 | L2 | L3 | L4 | L6 | L7 | L9 | L10 | L12 | L13 |
|----------------|----|----|----|----|----|----|----|-----|-----|-----|
| CPE18-M1H-3... | 94 | 69 | 50 | 28 | 38 | 18 | 44 | 28  | 5.5 | 29  |

Datasheet

Dimensions – 5/2-way single solenoid valve Download CAD data → [www.festo.com](http://www.festo.com)

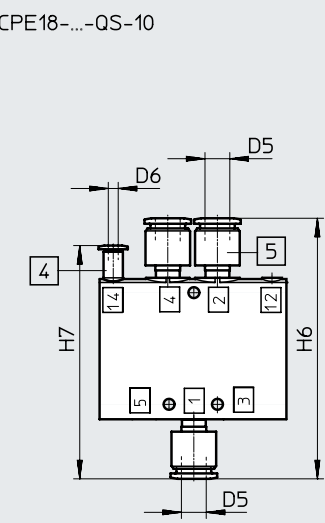
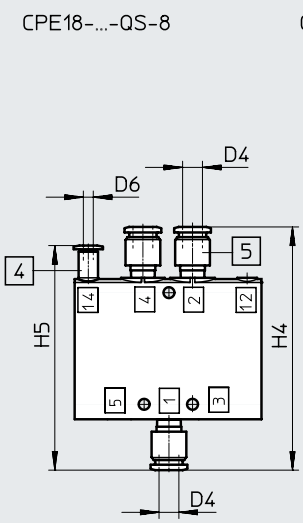
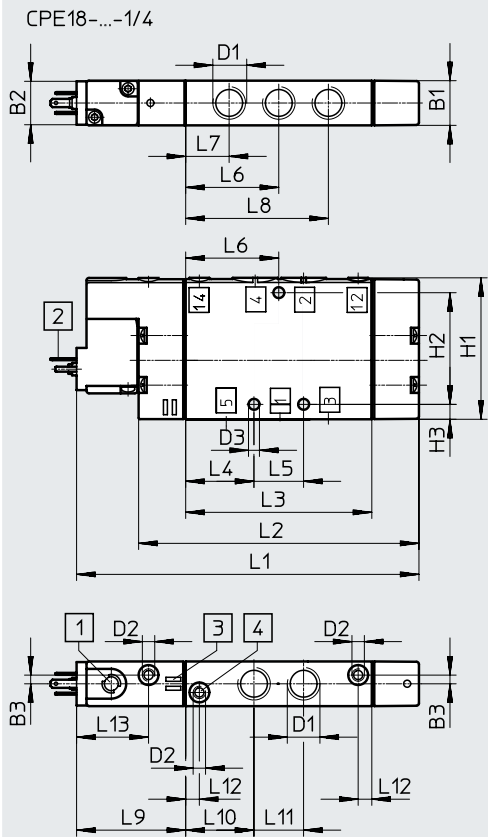

- [1] Manual override
- [2] Plug type C, to EN 175301-803
- [3] Space for inscription labels
- [4] Port 12/14 for external pilot air supply
- [5] QS push-in fitting

| Type           | B1 | B2   | B3  | D1   | D2 | D3<br>∅ | D4<br>∅ | D5<br>∅ | D6<br>∅ | H1 | H2 | H3 | H4 | H5   | H6  | H7 |
|----------------|----|------|-----|------|----|---------|---------|---------|---------|----|----|----|----|------|-----|----|
| CPE18-M1H-5... | 18 | 17.5 | 3.5 | G1/4 | M5 | 4.4     | 8       | 10      | 4       | 57 | 45 | 6  | 98 | 90.5 | 105 | 94 |

| Type           | L1  | L2  | L3 | L4   | L5 | L6   | L7   | L8   | L9 | L10  | L11 | L12 | L13 |
|----------------|-----|-----|----|------|----|------|------|------|----|------|-----|-----|-----|
| CPE18-M1H-5... | 138 | 113 | 75 | 27.5 | 20 | 37.5 | 17.5 | 57.5 | 44 | 27.5 | 20  | 5.5 | 29  |



Datasheet

Dimensions – 5/2-way double solenoid valve

Download CAD data → [www.festo.com](http://www.festo.com)

CPE18-...-1/4

CPE18-...-QS-8

CPE18-...-QS-10

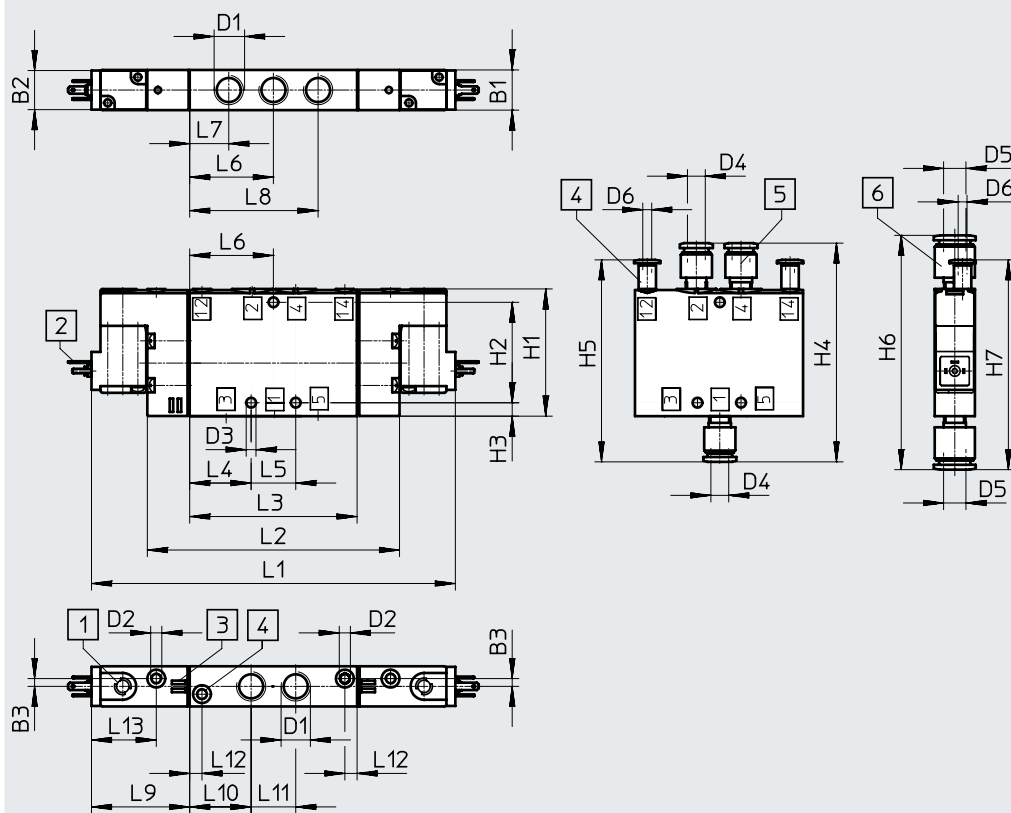

- [1] Manual override
- [2] Plug type C, to EN 175301-803
- [3] Space for inscription labels
- [4] Port 12/14 for external pilot air supply
- [5]/[6] QS push-in fitting

| Type              | B1 | B2   | B3  | D1   | D2 | D3  | D4 | D5 | D6 | H1 | H2 | H3 | H4 | H5   | H6  | H7 |
|-------------------|----|------|-----|------|----|-----|----|----|----|----|----|----|----|------|-----|----|
| CPE18-...-5/1-1/4 | 18 | 17.5 | 3.5 | G1/4 | M5 | 4.4 | 8  | 10 | 4  | 57 | 45 | 6  | 98 | 90.5 | 105 | 94 |

| Type              | L1  | L2  | L3 | L4   | L5 | L6   | L7   | L8   | L9 | L10  | L11 | L12 | L13 |
|-------------------|-----|-----|----|------|----|------|------|------|----|------|-----|-----|-----|
| CPE18-...-5/1-1/4 | 163 | 113 | 75 | 27.5 | 20 | 37.5 | 17.5 | 57.5 | 44 | 27.5 | 20  | 5.5 | 29  |

Datasheet

Dimensions – 5/3-way valve

Download CAD data → [www.festo.com](http://www.festo.com)

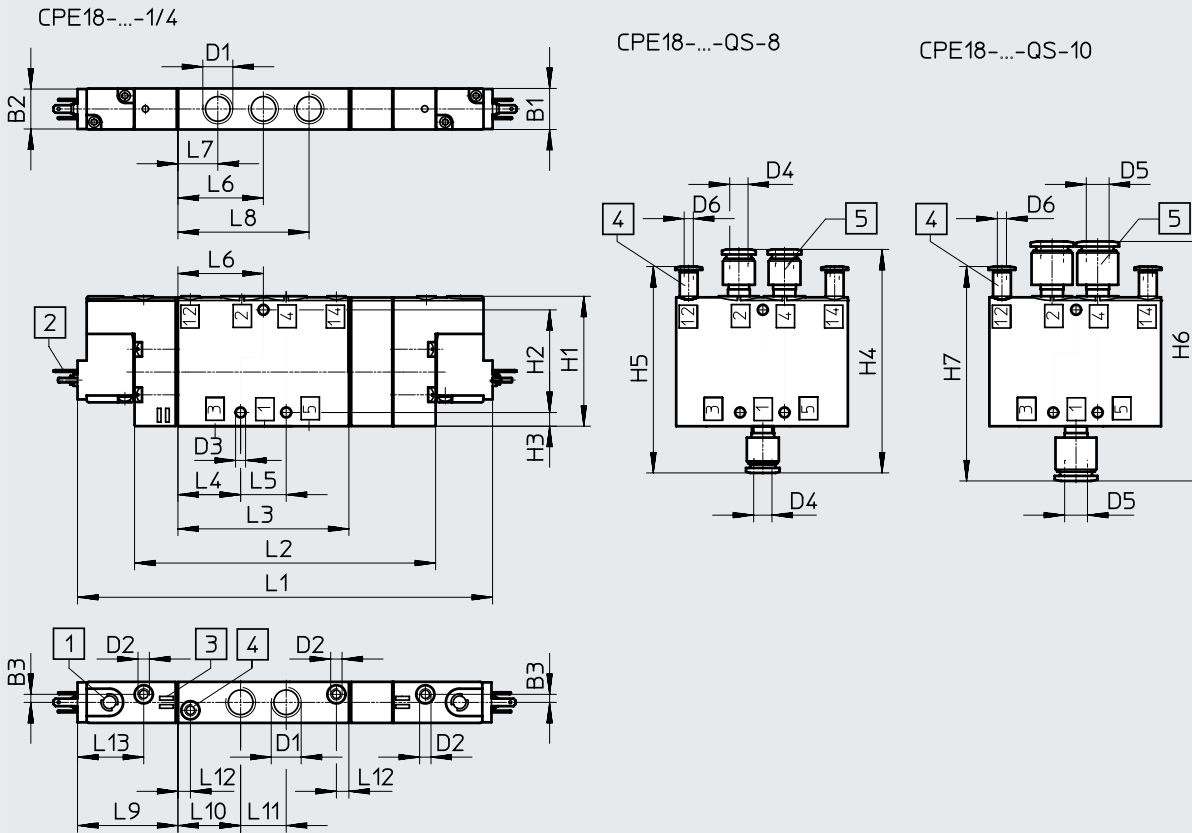

- [1] Manual override
- [2] Plug type C, to EN 175301-803
- [3] Space for inscription labels
- [4] Port 12/14 for external pilot air supply
- [5] QS push-in fitting

| Type             | B1 | B2   | B3  | D1   | D2 | D3<br>∅ | D4<br>∅ | D5<br>∅ | D6<br>∅ | H1 | H2 | H3 | H4 | H5   | H6  | H7 |
|------------------|----|------|-----|------|----|---------|---------|---------|---------|----|----|----|----|------|-----|----|
| CPE18-M1H...-5L  | 18 | 17.5 | 3.5 | G1/4 | M5 | 4.4     | 8       | 10      | 4       | 57 | 45 | 6  | 98 | 90.5 | 105 | 94 |
| CPE18-M1H...-5/3 |    |      |     |      |    |         |         |         |         |    |    |    |    |      |     |    |

| Type             | L1  | L2  | L3 | L4   | L5 | L6   | L7   | L8   | L9 | L10  | L11 | L12 | L13 |
|------------------|-----|-----|----|------|----|------|------|------|----|------|-----|-----|-----|
| CPE18-M1H...-5J  | 163 | 113 | 75 | 27.5 | 20 | 37.5 | 17.5 | 57.5 | 44 | 27.5 | 20  | 5.5 | 29  |
| CPE18-M1H...-5/3 | 182 | 132 |    |      |    |      |      |      |    |      |     |     |     |

## Ordering data

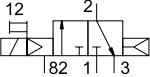
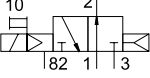
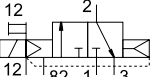
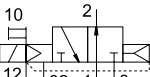
| Ordering data – 3/2-way valve   |                  |          |                      |            |          |                      |        |                      |
|---|------------------|----------|----------------------|------------|----------|----------------------|--------|----------------------|
| Circuit symbol  | Pilot air supply | Voltage  | Pneumatic connection | Weight [g] | Part no. | Type                 |        |                      |
| <b>Normally closed</b>  |                  |          |                      |            |          |                      |        |                      |
|    | Internal         | 24 V DC  | G1/4                 | 150        | 163141   | CPE18-M1H-3GL-1/4    |        |                      |
|   |                  |          | QS-8                 | –          | 163149   | CPE18-M1H-3GL-QS-8   |        |                      |
|   |                  |          | QS-10                | –          | 163157   | CPE18-M1H-3GL-QS-10  |        |                      |
|   |                  | 110 V AC | Internal             | 24 V DC    | G1/4     | 150                  | 163761 | CPE18-M2H-3GL-1/4    |
|   |                  |          |                      |            | QS-8     | –                    | 163769 | CPE18-M2H-3GL-QS-8   |
|   |                  |          |                      |            | QS-10    | –                    | 163777 | CPE18-M2H-3GL-QS-10  |
|   |                  | 230 V AC | Internal             | 24 V DC    | G1/4     | 150                  | 163785 | CPE18-M3H-3GL-1/4    |
|   |                  |          |                      |            | QS-8     | –                    | 163793 | CPE18-M3H-3GL-QS-8   |
|   |                  |          |                      |            | QS-10    | –                    | 163801 | CPE18-M3H-3GL-QS-10  |
| <b>Normally open</b>  |                  |          |                      |            |          |                      |        |                      |
|    | Internal         | 24 V DC  | G1/4                 | 150        | 163140   | CPE18-M1H-3OL-1/4    |        |                      |
|   |                  |          | QS-8                 | –          | 163148   | CPE18-M1H-3OL-QS-8   |        |                      |
|   |                  |          | QS-10                | –          | 163156   | CPE18-M1H-3OL-QS-10  |        |                      |
|   |                  | 110 V AC | Internal             | 24 V DC    | G1/4     | 150                  | 163760 | CPE18-M2H-3OL-1/4    |
|   |                  |          |                      |            | QS-8     | –                    | 163768 | CPE18-M2H-3OL-QS-8   |
|   |                  |          |                      |            | QS-10    | –                    | 163776 | CPE18-M2H-3OL-QS-10  |
|   |                  | 230 V AC | Internal             | 24 V DC    | G1/4     | 150                  | 163784 | CPE18-M3H-3OL-1/4    |
|   |                  |          |                      |            | QS-8     | –                    | 163792 | CPE18-M3H-3OL-QS-8   |
|   |                  |          |                      |            | QS-10    | –                    | 163800 | CPE18-M3H-3OL-QS-10  |
| <b>Normally closed</b>  |                  |          |                      |            |          |                      |        |                      |
|   | External         | 24 V DC  | G1/4                 | 150        | 163145   | CPE18-M1H-3GLS-1/4   |        |                      |
|   |                  |          | QS-8                 | –          | 163153   | CPE18-M1H-3GLS-QS-8  |        |                      |
|   |                  |          | QS-10                | –          | 163161   | CPE18-M1H-3GLS-QS-10 |        |                      |
|   |                  | 110 V AC | External             | 24 V DC    | G1/4     | 150                  | 163765 | CPE18-M2H-3GLS-1/4   |
|   |                  |          |                      |            | QS-8     | –                    | 163773 | CPE18-M2H-3GLS-QS-8  |
|   |                  |          |                      |            | QS-10    | –                    | 163781 | CPE18-M2H-3GLS-QS-10 |
|   |                  | 230 V AC | External             | 24 V DC    | G1/4     | 150                  | 163789 | CPE18-M3H-3GLS-1/4   |
|   |                  |          |                      |            | QS-8     | –                    | 163797 | CPE18-M3H-3GLS-QS-8  |
|   |                  |          |                      |            | QS-10    | –                    | 163805 | CPE18-M3H-3GLS-QS-10 |
| <b>Normally open</b>  |                  |          |                      |            |          |                      |        |                      |
|  | External         | 24 V DC  | G1/4                 | 150        | 163144   | CPE18-M1H-3OLS-1/4   |        |                      |
|   |                  |          | QS-8                 | –          | 163152   | CPE18-M1H-3OLS-QS-8  |        |                      |
|   |                  |          | QS-10                | –          | 163160   | CPE18-M1H-3OLS-QS-10 |        |                      |
|   |                  | 110 V AC | External             | 24 V DC    | G1/4     | 150                  | 163764 | CPE18-M2H-3OLS-1/4   |
|   |                  |          |                      |            | QS-8     | –                    | 163772 | CPE18-M2H-3OLS-QS-8  |
|   |                  |          |                      |            | QS-10    | –                    | 163780 | CPE18-M2H-3OLS-QS-10 |
|   |                  | 230 V AC | External             | 24 V DC    | G1/4     | 150                  | 163788 | CPE18-M3H-3OLS-1/4   |
|   |                  |          |                      |            | QS-8     | –                    | 163796 | CPE18-M3H-3OLS-QS-8  |
|   |                  |          |                      |            | QS-10    | –                    | 163804 | CPE18-M3H-3OLS-QS-10 |

## Ordering data

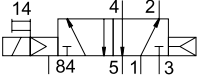
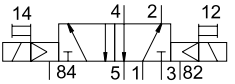
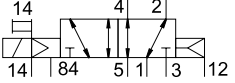
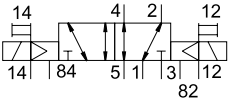
| Ordering data – 5/2-way valve  |                  |          |                      |            |          |                     |                     |
|--|------------------|----------|----------------------|------------|----------|---------------------|---------------------|
| Circuit symbol   | Pilot air supply | Voltage  | Pneumatic connection | Weight [g] | Part no. | Type                |                     |
| <b>5/2-way valve, single solenoid</b>  |                  |          |                      |            |          |                     |                     |
|    | Internal         | 24 V DC  | G1/4                 | 220        | 163142   | CPE18-M1H-5L-1/4    |                     |
|  |                  |          | QS-8                 | –          | 163150   | CPE18-M1H-5L-QS-8   |                     |
|  |                  |          | QS-10                | –          | 163158   | CPE18-M1H-5L-QS-10  |                     |
|  |                  | 110 V AC | Internal             | G1/4       | 220      | 163762              | CPE18-M2H-5L-1/4    |
|  |                  |          |                      | QS-8       | –        | 163770              | CPE18-M2H-5L-QS-8   |
|  |                  |          |                      | QS-10      | –        | 163778              | CPE18-M2H-5L-QS-10  |
|  |                  | 230 V AC | Internal             | G1/4       | 220      | 163786              | CPE18-M3H-5L-1/4    |
|  |                  |          |                      | QS-8       | –        | 163794              | CPE18-M3H-5L-QS-8   |
|  |                  |          |                      | QS-10      | –        | 163802              | CPE18-M3H-5L-QS-10  |
| <b>5/2-way double pilot valve</b>  |                  |          |                      |            |          |                     |                     |
|    | Internal         | 24 V DC  | G1/4                 | 270        | 163143   | CPE18-M1H-5J-1/4    |                     |
|  |                  |          | QS-8                 | –          | 163151   | CPE18-M1H-5J-QS-8   |                     |
|  |                  |          | QS-10                | –          | 163159   | CPE18-M1H-5J-QS-10  |                     |
|  |                  | 110 V AC | Internal             | G1/4       | 270      | 163763              | CPE18-M2H-5J-1/4    |
|  |                  |          |                      | QS-8       | –        | 163771              | CPE18-M2H-5J-QS-8   |
|  |                  |          |                      | QS-10      | –        | 163779              | CPE18-M2H-5J-QS-10  |
|  |                  | 230 V AC | Internal             | G1/4       | 270      | 163787              | CPE18-M3H-5J-1/4    |
|  |                  |          |                      | QS-8       | –        | 163795              | CPE18-M3H-5J-QS-8   |
|  |                  |          |                      | QS-10      | –        | 163803              | CPE18-M3H-5J-QS-10  |
| <b>5/2-way valve, single solenoid</b>  |                  |          |                      |            |          |                     |                     |
|   | External         | 24 V DC  | G1/4                 | 220        | 163146   | CPE18-M1H-5LS-1/4   |                     |
|  |                  |          | QS-8                 | –          | 163154   | CPE18-M1H-5LS-QS-8  |                     |
|  |                  |          | QS-10                | –          | 163162   | CPE18-M1H-5LS-QS-10 |                     |
|  |                  | 110 V AC | External             | G1/4       | 220      | 163766              | CPE18-M2H-5LS-1/4   |
|  |                  |          |                      | QS-8       | –        | 163774              | CPE18-M2H-5LS-QS-8  |
|  |                  |          |                      | QS-10      | –        | 163782              | CPE18-M2H-5LS-QS-10 |
|  |                  | 230 V AC | External             | G1/4       | 220      | 163790              | CPE18-M3H-5LS-1/4   |
|  |                  |          |                      | QS-8       | –        | 163798              | CPE18-M3H-5LS-QS-8  |
|  |                  |          |                      | QS-10      | –        | 163806              | CPE18-M3H-5LS-QS-10 |
| <b>5/2-way double pilot valve</b>  |                  |          |                      |            |          |                     |                     |
|  | External         | 24 V DC  | G1/4                 | 270        | 163147   | CPE18-M1H-5JS-1/4   |                     |
|  |                  |          | QS-8                 | –          | 163155   | CPE18-M1H-5JS-QS-8  |                     |
|  |                  |          | QS-10                | –          | 163163   | CPE18-M1H-5JS-QS-10 |                     |
|  |                  | 110 V AC | External             | G1/4       | 270      | 163767              | CPE18-M2H-5JS-1/4   |
|  |                  |          |                      | QS-8       | –        | 163775              | CPE18-M2H-5JS-QS-8  |
|  |                  |          |                      | QS-10      | –        | 163783              | CPE18-M2H-5JS-QS-10 |
|  |                  | 230 V AC | External             | G1/4       | 270      | 163791              | CPE18-M3H-5JS-1/4   |
|  |                  |          |                      | QS-8       | –        | 163799              | CPE18-M3H-5JS-QS-8  |
|  |                  |          |                      | QS-10      | –        | 163807              | CPE18-M3H-5JS-QS-10 |

## Ordering data

| Ordering data – 5/3-way valve                         |                  |          |                      |            |          |                      |        |                      |
|---|------------------|----------|----------------------|------------|----------|----------------------|--------|----------------------|
| Circuit symbol  | Pilot air supply | Voltage  | Pneumatic connection | Weight [g] | Part no. | Type                 |        |                      |
| <b>5/3-way mid-position valve, normally closed</b>    |                  |          |                      |            |          |                      |        |                      |
|   | Internal         | 24 V DC  | G1/4                 | 280        | 170247   | CPE18-M1H-5/3G-1/4   |        |                      |
|   |                  |          | QS-8                 | –          | 170253   | CPE18-M1H-5/3G-QS-8  |        |                      |
|   |                  |          | QS-10                | –          | 170259   | CPE18-M1H-5/3G-QS-10 |        |                      |
|   |                  | 110 V AC | Internal             | 24 V DC    | G1/4     | 280                  | 170283 | CPE18-M2H-5/3G-1/4   |
|   |                  |          |                      |            | QS-8     | –                    | 170289 | CPE18-M2H-5/3G-QS-8  |
|   |                  |          |                      |            | QS-10    | –                    | 170295 | CPE18-M2H-5/3G-QS-10 |
|   |                  | 230 V AC | Internal             | 24 V DC    | G1/4     | 280                  | 170319 | CPE18-M3H-5/3G-1/4   |
|   |                  |          |                      |            | QS-8     | –                    | 170325 | CPE18-M3H-5/3G-QS-8  |
|   |                  |          |                      |            | QS-10    | –                    | 170331 | CPE18-M3H-5/3G-QS-10 |
| <b>5/3-way mid-position valve, normally exhausted</b> |                  |          |                      |            |          |                      |        |                      |
|   | Internal         | 24 V DC  | G1/4                 | 280        | 170249   | CPE18-M1H-5/3E-1/4   |        |                      |
|   |                  |          | QS-8                 | –          | 170255   | CPE18-M1H-5/3E-QS-8  |        |                      |
|   |                  |          | QS-10                | –          | 170261   | CPE18-M1H-5/3E-QS-10 |        |                      |
|   |                  | 110 V AC | Internal             | 24 V DC    | G1/4     | 280                  | 170285 | CPE18-M2H-5/3E-1/4   |
|   |                  |          |                      |            | QS-8     | –                    | 170291 | CPE18-M2H-5/3E-QS-8  |
|   |                  |          |                      |            | QS-10    | –                    | 170297 | CPE18-M2H-5/3E-QS-10 |
|   |                  | 230 V AC | Internal             | 24 V DC    | G1/4     | 280                  | 170321 | CPE18-M3H-5/3E-1/4   |
|   |                  |          |                      |            | QS-8     | –                    | 170327 | CPE18-M3H-5/3E-QS-8  |
|   |                  |          |                      |            | QS-10    | –                    | 170333 | CPE18-M3H-5/3E-QS-10 |
| <b>5/3-way mid-position valve, normally open</b>      |                  |          |                      |            |          |                      |        |                      |
|   | Internal         | 24 V DC  | G1/4                 | 280        | 170251   | CPE18-M1H-5/3B-1/4   |        |                      |
|   |                  |          | QS-8                 | –          | 170257   | CPE18-M1H-5/3B-QS8   |        |                      |
|   |                  |          | QS-10                | –          | 170263   | CPE18-M1H-5/3B-QS10  |        |                      |
|   |                  | 110 V AC | Internal             | 24 V DC    | G1/4     | 280                  | 170287 | CPE18-M2H-5/3B-1/4   |
|   |                  |          |                      |            | QS-8     | –                    | 170293 | CPE18-M2H-5/3B-QS-8  |
|   |                  |          |                      |            | QS-10    | –                    | 170299 | CPE18-M2H-5/3B-QS-10 |
|   |                  | 230 V AC | Internal             | 24 V DC    | G1/4     | 280                  | 170323 | CPE18-M3H-5/3B-1/4   |
|   |                  |          |                      |            | QS-8     | –                    | 170329 | CPE18-M3H-5/3B-QS-8  |
|   |                  |          |                      |            | QS-10    | –                    | 170335 | CPE18-M3H-5/3B-QS-10 |

## Ordering data

| Ordering data – 5/3-way valve                         |                  |          |                      |            |               |                       |               |                       |
|---|------------------|----------|----------------------|------------|---------------|-----------------------|---------------|-----------------------|
| Circuit symbol  | Pilot air supply | Voltage  | Pneumatic connection | Weight [g] | Part no.      | Type                  |               |                       |
| <b>5/3-way mid-position valve, normally closed</b>    |                  |          |                      |            |               |                       |               |                       |
|   | External         | 24 V DC  | G1/4                 | 280        | <b>170248</b> | CPE18-M1H-5/3GS-1/4   |               |                       |
|   |                  |          | QS-8                 | –          | <b>170254</b> | CPE18-M1H-5/3GS-QS-8  |               |                       |
|   |                  |          | QS-10                | –          | <b>170260</b> | CPE18-M1H-5/3GS-QS-10 |               |                       |
|   |                  | 110 V AC | External             | 24 V DC    | G1/4          | 280                   | <b>170284</b> | CPE18-M2H-5/3GS-1/4   |
|   |                  |          |                      |            | QS-8          | –                     | <b>170290</b> | CPE18-M2H-5/3GS-QS-8  |
|   |                  |          |                      |            | QS-10         | –                     | <b>170296</b> | CPE18-M2H-5/3GS-QS-10 |
|   |                  | 230 V AC | External             | 24 V DC    | G1/4          | 280                   | <b>170320</b> | CPE18-M3H-5/3GS-1/4   |
|   |                  |          |                      |            | QS-8          | –                     | <b>170326</b> | CPE18-M3H-5/3GS-QS-8  |
|   |                  |          |                      |            | QS-10         | –                     | <b>170332</b> | CPE18-M3H-5/3GS-QS-10 |
| <b>5/3-way mid-position valve, normally exhausted</b> |                  |          |                      |            |               |                       |               |                       |
|   | External         | 24 V DC  | G1/4                 | 280        | <b>170250</b> | CPE18-M1H-5/3ES-1/4   |               |                       |
|   |                  |          | QS-8                 | –          | <b>170256</b> | CPE18-M1H-5/3ES-QS-8  |               |                       |
|   |                  |          | QS-10                | –          | <b>170262</b> | CPE18-M1H-5/3ES-QS-10 |               |                       |
|   |                  | 110 V AC | External             | 24 V DC    | G1/4          | 280                   | <b>170286</b> | CPE18-M2H-5/3ES-1/4   |
|   |                  |          |                      |            | QS-8          | –                     | <b>170292</b> | CPE18-M2H-5/3ES-QS-8  |
|   |                  |          |                      |            | QS-10         | –                     | <b>170298</b> | CPE18-M2H-5/3ES-QS-10 |
|   |                  | 230 V AC | External             | 24 V DC    | G1/4          | 280                   | <b>170322</b> | CPE18-M3H-5/3ES-1/4   |
|   |                  |          |                      |            | QS-8          | –                     | <b>170328</b> | CPE18-M3H-5/3ES-QS-8  |
|   |                  |          |                      |            | QS-10         | –                     | <b>170334</b> | CPE18-M3H-5/3ES-QS-10 |
| <b>5/3-way mid-position valve, normally open</b>      |                  |          |                      |            |               |                       |               |                       |
|   | External         | 24 V DC  | G1/4                 | 280        | <b>170252</b> | CPE18-M1H-5/3BS-1/4   |               |                       |
|   |                  |          | QS-8                 | –          | <b>170258</b> | CPE18-M1H-5/3BS-QS-8  |               |                       |
|   |                  |          | QS-10                | –          | <b>170264</b> | CPE18-M1H-5/3BS-QS-10 |               |                       |
|   |                  | 110 V AC | External             | 24 V DC    | G1/4          | 280                   | <b>170288</b> | CPE18-M2H-5/3BS-1/4   |
|   |                  |          |                      |            | QS-8          | –                     | <b>170294</b> | CPE18-M2H-5/3BS-QS-8  |
|   |                  |          |                      |            | QS-10         | –                     | <b>170300</b> | CPE18-M2H-5/3BS-QS-10 |
|   |                  | 230 V AC | External             | 24 V DC    | G1/4          | 280                   | <b>170324</b> | CPE18-M3H-5/3BS-1/4   |
|   |                  |          |                      |            | QS-8          | –                     | <b>170330</b> | CPE18-M3H-5/3BS-QS-8  |
|   |                  |          |                      |            | QS-10         | –                     | <b>170336</b> | CPE18-M3H-5/3BS-QS-10 |

Technical data – Directional control valves without pilot valve

Materials

Sectional view

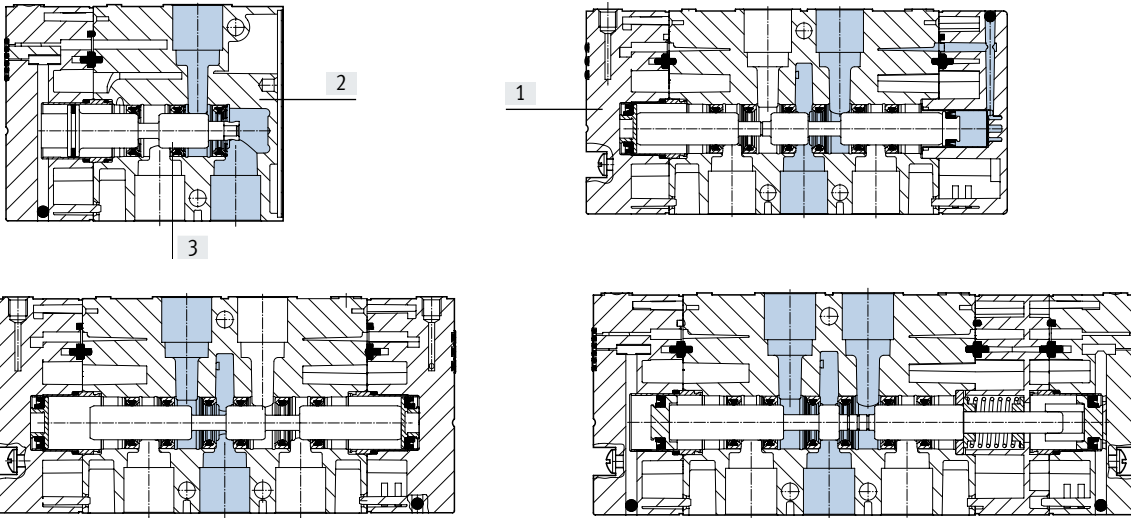

|                   |                    |
|-------------------|--------------------|
| [1] Cover         | PA                 |
| [2] Housing       | Die-cast aluminium |
| [3] Piston spool  | Steel              |
| - Seals           | NBR                |
| Note on materials | RoHS-compliant     |

Dimensions – 3/2-way valve

Download CAD data → [www.festo.com](http://www.festo.com)

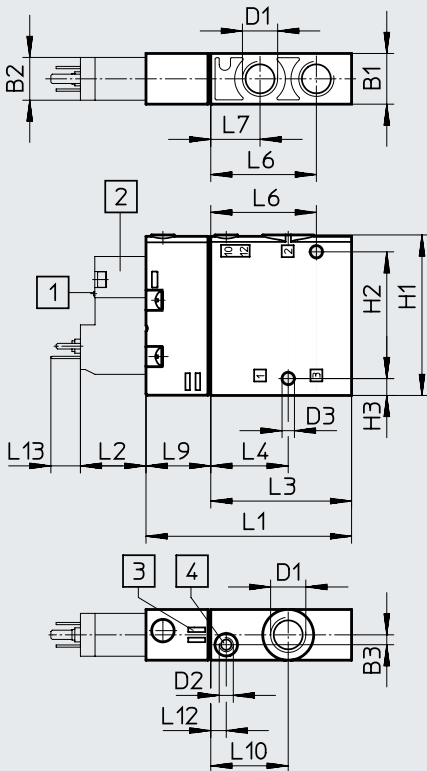

- [1] Manual override
- [2] Pilot valve, plug type C to EN 175301-803
- [3] Space for inscription label
- [4] Port 10/12 for external pilot air supply

| Type       | B1 | B2   | B3  | D1   | D2 | D3<br>∅ | H1 | H2 | H3 | L1 | L2   | L3 | L4   | L6   | L7   | L9 | L10  | L12 | L13  |
|------------|----|------|-----|------|----|---------|----|----|----|----|------|----|------|------|------|----|------|-----|------|
| CPE18-P1-3 | 18 | 15.2 | 3.5 | G1/4 | M5 | 4.4     | 57 | 45 | 6  | 73 | 23.3 | 50 | 27.5 | 37.5 | 17.5 | 23 | 27.5 | 5.5 | 10.5 |

Technical data – Directional control valves without pilot valve

Dimensions – 5/2-way valve

Download CAD data → [www.festo.com](http://www.festo.com)

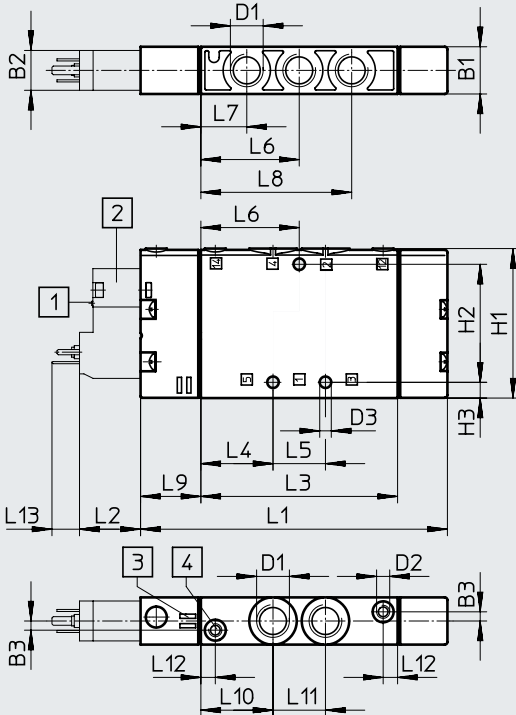

- [1] Manual override
- [2] Pilot valve, plug type C to EN 175301-803
- [3] Space for inscription label
- [4] Port 12/14 for external pilot air supply

| Type        | B1 | B2   | B3  | D1   | D2 | D3  | H1 | H2 | H3 | L1  | L2   | L3 | L4   | L5 | L6   | L7   | L8   | L9 | L10  | L11 | L12 | L13  |
|-------------|----|------|-----|------|----|-----|----|----|----|-----|------|----|------|----|------|------|------|----|------|-----|-----|------|
| CPE18-P1-5L | 18 | 15.2 | 3.5 | G1/4 | M5 | 4.4 | 57 | 45 | 6  | 117 | 23.3 | 75 | 27.5 | 20 | 37.5 | 17.5 | 57.5 | 23 | 27.5 | 20  | 5.5 | 10.5 |

Dimensions – 5/2-way double pilot valve

Download CAD data → [www.festo.com](http://www.festo.com)

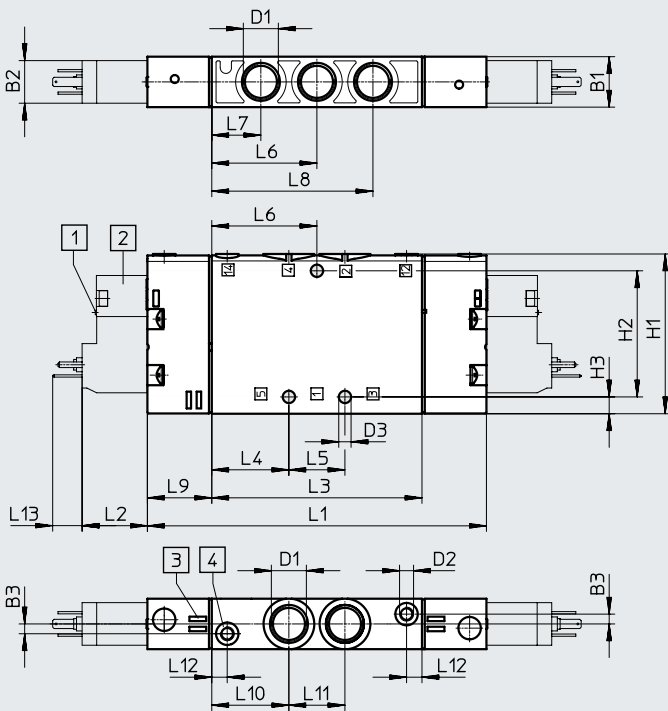

- [1] Manual override
- [2] Pilot valve, plug type C to EN 175301-803
- [3] Space for inscription label
- [4] Port 12/14 for external pilot air supply

| Type        | B1 | B2   | B3  | D1   | D2 | D3  | H1 | H2 | H3 | L1  | L2   | L3 | L4   | L5 | L6   | L7   | L8   | L9 | L10  | L11 | L12 | L13  |
|-------------|----|------|-----|------|----|-----|----|----|----|-----|------|----|------|----|------|------|------|----|------|-----|-----|------|
| CPE18-P1-5J | 18 | 15.2 | 3.5 | G1/4 | M5 | 4.4 | 57 | 45 | 6  | 121 | 23.3 | 75 | 27.5 | 20 | 37.5 | 17.5 | 57.5 | 23 | 27.5 | 20  | 5.5 | 10.5 |



Technical data – Directional control valves without pilot valve

Dimensions – 5/3-way valve

Download CAD data → [www.festo.com](http://www.festo.com)

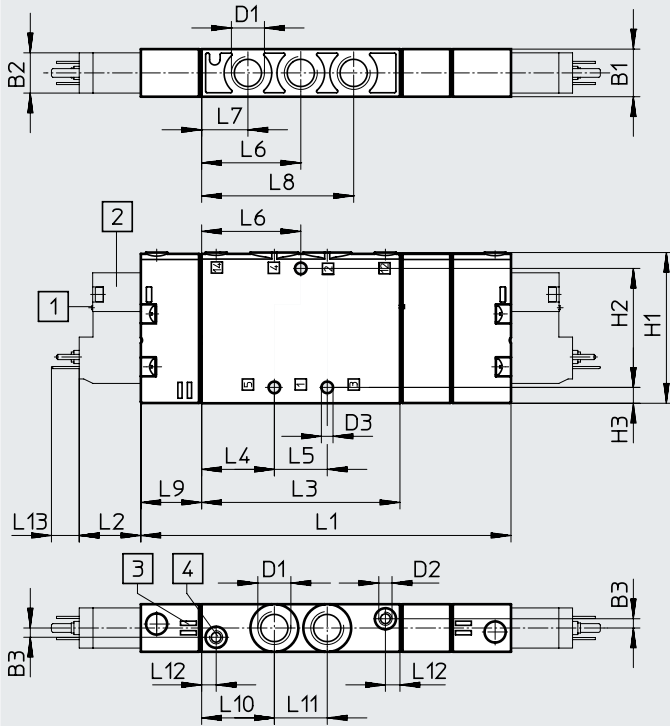

- [1] Manual override
- [2] Pilot valve, plug type C to EN 175301-803
- [3] Space for inscription label
- [4] Port 12/14 for external pilot air supply

| Type         | B1 | B2   | B3  | D1   | D2 | D3<br>∅ | H1 | H2 | H3 | L1  | L2   | L3 | L4   | L5 | L6   | L7   | L8   | L9 | L10  | L11 | L12 | L13  |
|--------------|----|------|-----|------|----|---------|----|----|----|-----|------|----|------|----|------|------|------|----|------|-----|-----|------|
| CPE18-P1-5J  | 18 | 15.2 | 3.5 | G1/4 | M5 | 4.4     | 57 | 45 | 6  | 121 | 23.3 | 75 | 27.5 | 20 | 37.5 | 17.5 | 57.5 | 23 | 27.5 | 20  | 5.5 | 10.5 |
| CPE18-P1-5/3 |    |      |     |      |    |         |    |    |    | 140 |      |    |      |    |      |      |      |    |      |     |     |      |

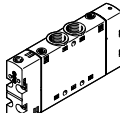

### Ordering data

| Ordering data – 3/2-way valve without pilot valve                                |                 |                  |            |          |                   |
|--|-----------------|------------------|------------|----------|-------------------|
| Design type  | Normal position | Pilot air supply | Weight [g] | Part no. | Type              |
|  | Closed          | Internal         | 110        | 550163   | CPE18-P1-3GL-1/4  |
|  | Open            |                  |            | 550165   | CPE18-P1-3OL-1/4  |
|  | Closed          | External         |            | 550164   | CPE18-P1-3GLS-1/4 |
|  | Open            |                  |            | 550166   | CPE18-P1-3OLS-1/4 |

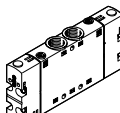
| Ordering data – 5/2-way single solenoid valve without pilot valve                |   |                  |            |          |                  |
|--|---|------------------|------------|----------|------------------|
| Design type  |   | Pilot air supply | Weight [g] | Part no. | Type             |
|  | – | Internal         | 180        | 550153   | CPE18-P1-5L-1/4  |
|  |   | External         |            | 550154   | CPE18-P1-5LS-1/4 |

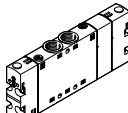
| Ordering data – 5/2-way double pilot valve without pilot valve                   |   |                  |            |          |                  |
|--|---|------------------|------------|----------|------------------|
| Design type  |   | Pilot air supply | Weight [g] | Part no. | Type             |
|  | – | Internal         | 190        | 550155   | CPE18-P1-5J-1/4  |
|  |   | External         |            | 550156   | CPE18-P1-5JS-1/4 |

| Ordering data – 5/3-way monostable mid-position valve without pilot valve          |                 |                  |            |          |                    |
|--|-----------------|------------------|------------|----------|--------------------|
| Design type  | Normal position | Pilot air supply | Weight [g] | Part no. | Type               |
|  | Closed          | Internal         | 200        | 550157   | CPE18-P1-5/3G-1/4  |
|  | Open            |                  |            | 550159   | CPE18-P1-5/3E-1/4  |
|  | Exhausted       |                  |            | 550161   | CPE18-P1-5/3B-1/4  |
|  | Closed          | External         |            | 550158   | CPE18-P1-5/3GS-1/4 |
|  | Open            |                  |            | 550160   | CPE18-P1-5/3ES-1/4 |
|  | Exhausted       |                  |            | 550162   | CPE18-P1-5/3BS-1/4 |

| Ordering data – Pilot valve to ISO 15218   |                         |              |       |      |         |        |          |                       |
|--|-------------------------|--------------|-------|------|---------|--------|----------|-----------------------|
| Design type  | Plug, square design     | PE conductor | Power |      | Voltage |        | Part no. | Type                  |
|  |                         |              | [W]   | [VA] | [V DC]  | [V AC] |          |                       |
|  | Type C to EN 175301-803 | No           | 1.8   | –    | 24      | –      | 546256   | VSCS-B-M32-MH-WA-1C1  |
|  |                         |              |       |      | 12      | –      | 546257   | VSCS-B-M32-MH-WA-5C1  |
|  | Type C to EN 175301-803 | Yes          | –     | 2.1  | –       | 230    | 546260   | VSCS-B-M32-MH-WA-3AC1 |
|  |                         | Yes          | –     | 2.1  | –       | 110    | 546259   | VSCS-B-M32-MH-WA-2AC1 |
|  | Type C to EN 175301-803 | No           | –     | 2.3  | –       | 24     | 546258   | VSCS-B-M32-MH-WA-1AC1 |

## Technical data – Fixed-grid manifold block

### Manifold block

For CPE18 5/2 and 5/3

Material:

Wrought aluminium alloy

RoHS-compliant

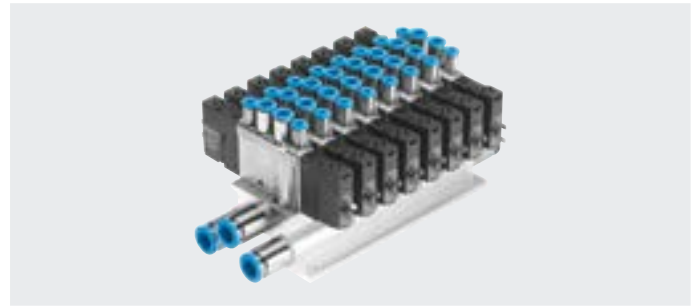

### Dimensions – Fixed-grid manifold 5/2 and 5/3

Download CAD data → [www.festo.com](http://www.festo.com)

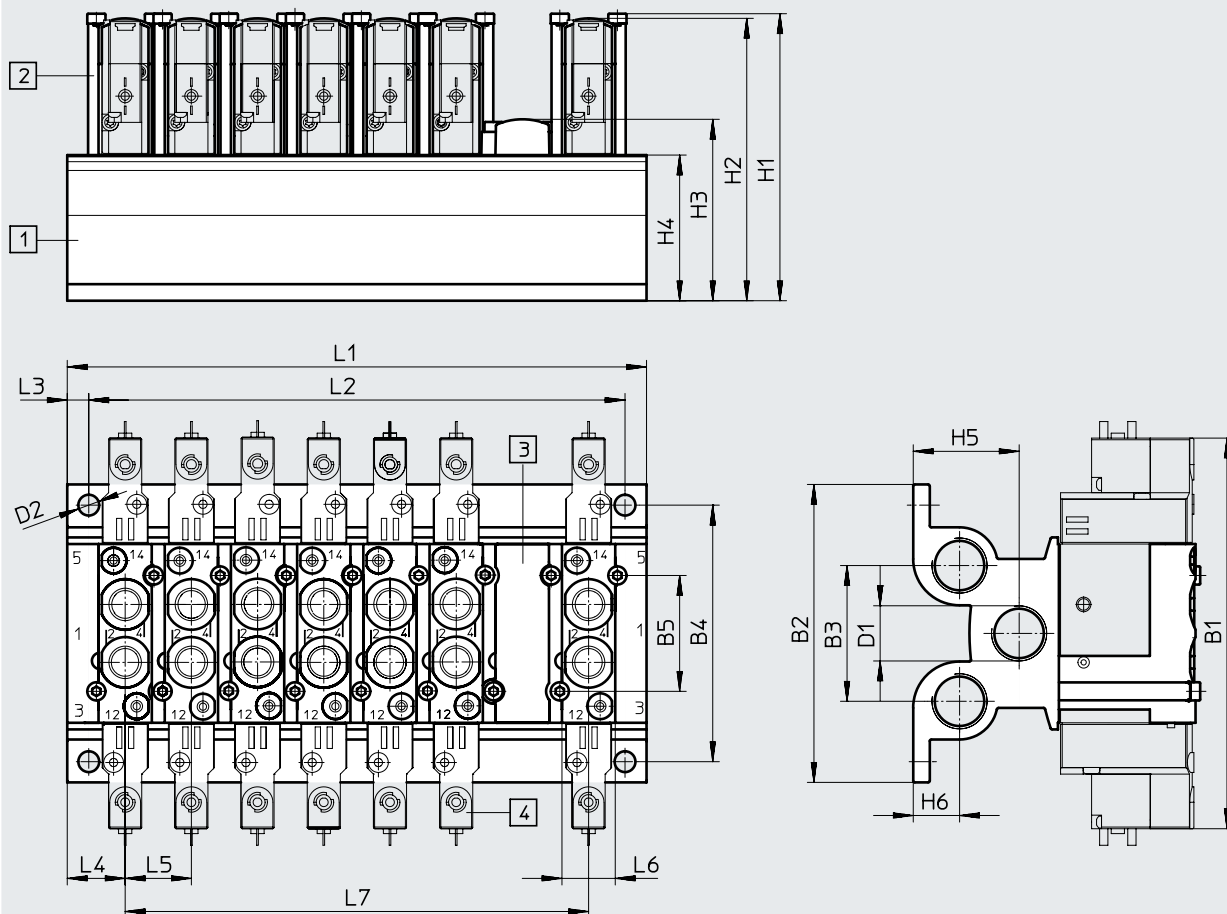

[1] Manifold block  
Grid dimension 26 mm

[2] Retaining bracket

[3] Cover plate

[4] Valves

| Type         | B1  | B2  | B3 | B4   | B5 | D1   | D2  | H1  | H2     | H3   | H4 | H5   | H6 |
|--------------|-----|-----|----|------|----|------|-----|-----|--------|------|----|------|----|
| CPE18-PRS... | 155 | 102 | 46 | 86.5 | 40 | G3/8 | 8.3 | 105 | 101.45 | 59.8 | 44 | 30.5 | 14 |



  

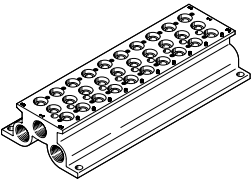

| Type         | L1              | L2            | L3  | L4   | L5 | L6   | L7         |
|--------------|-----------------|---------------|-----|------|----|------|------------|
| CPE18-PRS... | 45 + (n-1) x 26 | L1 - 17 ± 0.1 | 8.5 | 22.5 | 26 | 22.4 | (n-1) x 26 |

## Ordering data – Fixed-grid manifold block

| Ordering data  | Valve positions | CRC <sup>1)</sup> | Max. tightening torque for valve mounting [Nm] | Weight [g] | Part no. | Type             |
|--|-----------------|-------------------|--|------------|----------|------------------|
| <b>Manifold block for 5/2- and 5/3-way valves</b>                                |                 |                   |  |            |          |                  |
|  | 2               | 2                 | 2  | 353        | 543839   | CPE18-PRS-3/8-2  |
|  | 3               |                   |  | 482        | 543840   | CPE18-PRS-3/8-3  |
|  | 4               |                   |  | 611        | 543841   | CPE18-PRS-3/8-4  |
|  | 5               |                   |  | 740        | 543842   | CPE18-PRS-3/8-5  |
|  | 6               |                   |  | 870        | 543843   | CPE18-PRS-3/8-6  |
|  | 7               |                   |  | 999        | 543844   | CPE18-PRS-3/8-7  |
|  | 8               |                   |  | 1128       | 543845   | CPE18-PRS-3/8-8  |
|  | 9               |                   |  | 1257       | 543846   | CPE18-PRS-3/8-9  |
|  | 10              |                   |  | 1386       | 543847   | CPE18-PRS-3/8-10 |

1) Corrosion resistance class CRC 2 to Festo standard FN 940070  
 Moderate corrosion stress. Indoor applications in which condensation can occur. External visible parts with primarily decorative surface requirements which are in direct contact with a normal industrial environment.

| Ordering data  | Material  | Part no. | Type         |
|--|---|----------|--------------|
| <b>Cover plate for vacant position</b>   |   |          |              |
|    | PA  | 544481   | CPE18-RP     |
| <b>Retaining bracket set</b>   |   |          |              |
|  | Retaining bracket: high-alloy stainless steel<br>Screws: galvanised steel<br>Seals: NBR | 544396   | CPE18-H5-SET |

| Ordering data  | Material  | Part no. | Type               |
|--|---|----------|--------------------|
| <b>Retaining bracket</b>   |   |          |                    |
|  | Retaining bracket: high-alloy stainless steel<br>(packaging unit 50 pieces) | 547047   | CPE18-H5-50        |
| <b>Screws</b>  |   |          |                    |
|  | Galvanised steel<br>(packaging unit 100 pieces)                             | 547050   | M4X65-8.8-VS-100   |
| <b>Seals</b>   |   |          |                    |
|  | NBR<br>(packaging unit 150 pieces)  | 547053   | CPV18-VI-P.1/4-150 |

## Technical data – Fixed-grid manifold block

### Manifold block

For CPE18 3/2

Material:

Wrought aluminium alloy

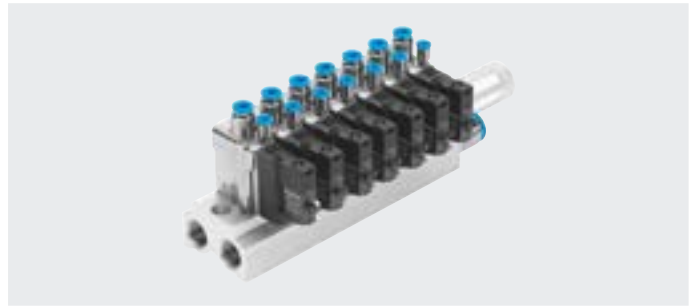

### Dimensions – Fixed-grid manifold block 3/2

Download CAD data → [www.festo.com](http://www.festo.com)

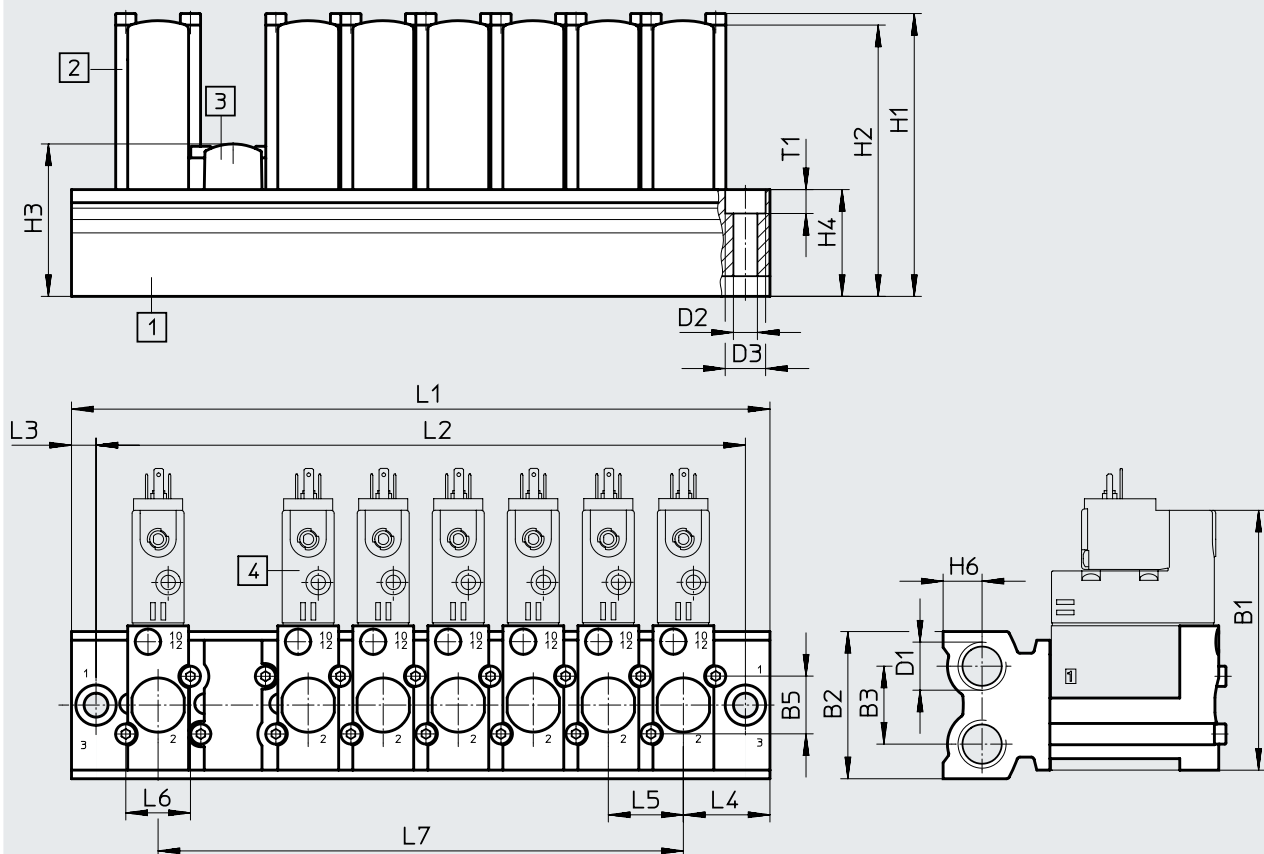

[1] Manifold block  
Grid dimension 26 mm

[2] Retaining bracket

[3] Cover plate

[4] Valves

| Type             | B1 | B2 | B3 | B5  | D1   | D2  | H1 | H2 | H3   | H4 | H6   |
|------------------|----|----|----|-----|------|-----|----|----|------|----|------|
| CPE18-3/2-PRS... | 90 | 51 | 27 | 200 | G3/8 | 8.3 | 98 | 94 | 52.8 | 37 | 13.5 |

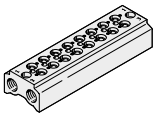

| Type             | L1                     | L2                     | L3  | L4 | L5 | L6   | L7                | T1  |
|------------------|------------------------|------------------------|-----|----|----|------|-------------------|-----|
| CPE18-3/2-PRS... | $60 + (n-1) \times 26$ | $43 + (n-1) \times 26$ | 8.5 | 24 | 26 | 22.4 | $(n-1) \times 26$ | 8.3 |

### Ordering data – Fixed-grid manifold block

| Ordering data  |                 |                   |  |            |          |                      |
|--|-----------------|-------------------|--|------------|----------|----------------------|
|  | Valve positions | CRC <sup>1)</sup> | Max. tightening torque for valve mounting [Nm] | Weight [g] | Part no. | Type                 |
| <b>Manifold block for 3/2-way valves</b>   |                 |                   |  |            |          |                      |
|  | 2               | 2                 | 2  | 266        | 550568   | CPE18-3/2-PRS-3/8-2  |
|  | 3               |                   |  | 346        | 550569   | CPE18-3/2-PRS-3/8-3  |
|  | 4               |                   |  | 426        | 550570   | CPE18-3/2-PRS-3/8-4  |
|  | 5               |                   |  | 507        | 550571   | CPE18-3/2-PRS-3/8-5  |
|  | 6               |                   |  | 587        | 550572   | CPE18-3/2-PRS-3/8-6  |
|  | 7               |                   |  | 667        | 550573   | CPE18-3/2-PRS-3/8-7  |
|  | 8               |                   |  | 748        | 550574   | CPE18-3/2-PRS-3/8-8  |
|  | 9               |                   |  | 828        | 550575   | CPE18-3/2-PRS-3/8-9  |
|  | 10              |                   |  | 908        | 550576   | CPE18-3/2-PRS-3/8-10 |

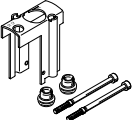
1) Corrosion resistance class CRC 2 to Festo standard FN 940070  
 Moderate corrosion stress. Indoor applications in which condensation can occur. External visible parts with primarily decorative surface requirements which are in direct contact with a normal industrial environment.

| Ordering data  |   |          |              |
|--|---|----------|--------------|
|  | Material  | Part no. | Type         |
| <b>Cover plate</b>   |   |          |              |
|    | PA  | 550582   | CPE18-RP3    |
| <b>Retaining bracket set</b>   |   |          |              |
|  | Retaining bracket: high-alloy stainless steel<br>Screws: galvanised steel<br>Seals: NBR | 550579   | CPE18-H3-SET |

| Ordering data  |   |          |                    |
|--|---|----------|--------------------|
|  | Material  | Part no. | Type               |
| <b>Retaining bracket</b>   |   |          |                    |
|  | Retaining bracket: high-alloy stainless steel<br>(packaging unit 50 pieces) | 551492   | CPE18-H3-50        |
| <b>Screws</b>  |   |          |                    |
|  | Galvanised steel<br>(packaging unit 100 pieces)                             | 547050   | M4X65-8.8-VS-100   |
| <b>Seals</b>   |   |          |                    |
|  | NBR<br>(packaging unit 150 pieces)  | 547053   | CPV18-VI-P.1/4-150 |

## Technical data – Modular manifold

### Modular manifold block

For CPE18 5/2 and 5/3

Material:  
Reinforced PA

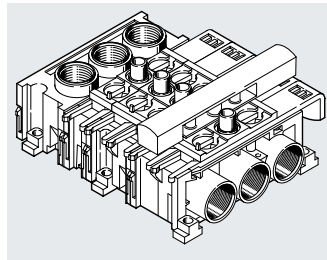

### Dimensions – Modular manifold block

Download CAD data → [www.festo.com](http://www.festo.com)

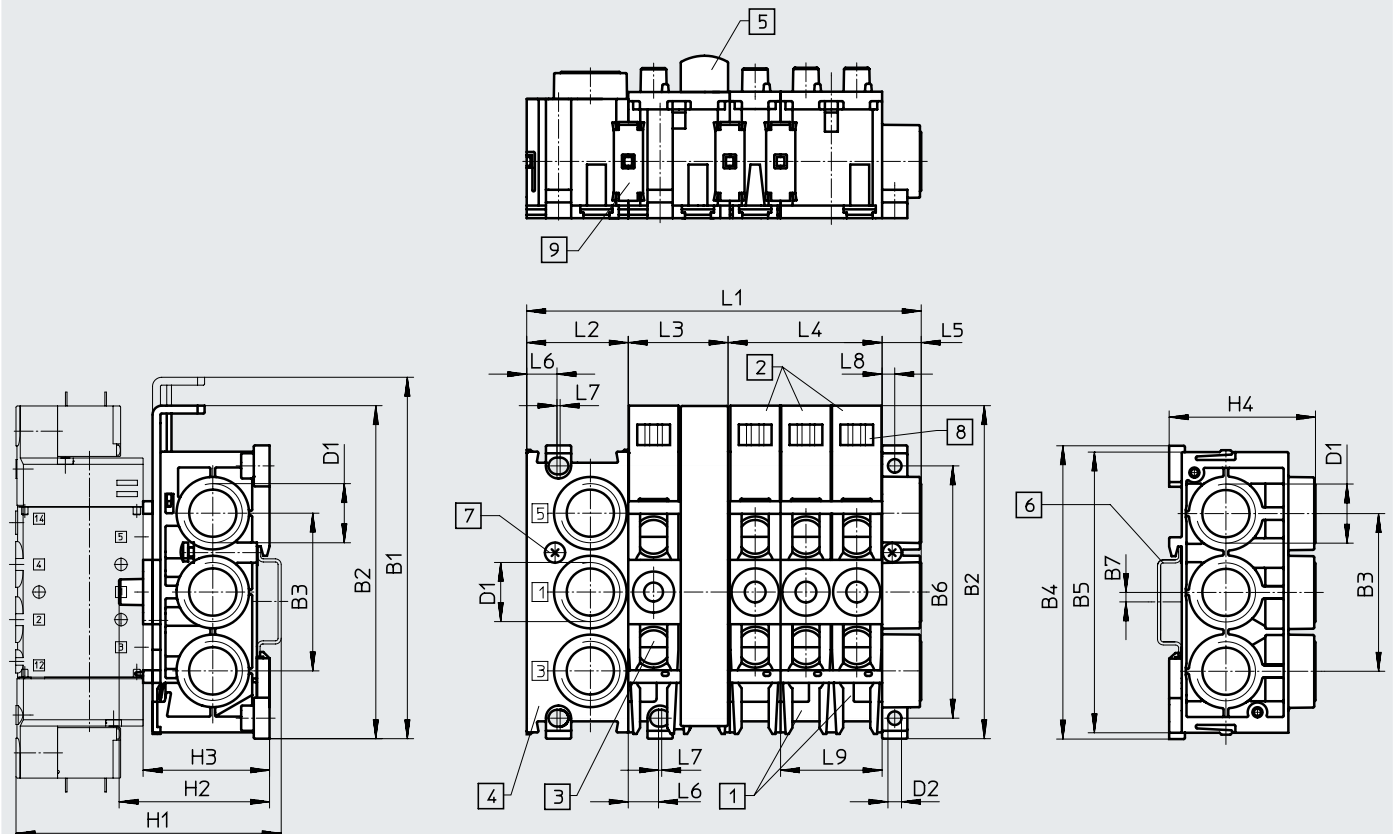

- [1] Manifold block  
CPE...-PRSG...-2 for  
2 valves
- [2] Manifold block  
CPE...-PRSG...-3 for  
3 valves
- [3] Expansion block  
CPE...-PRSE...-2 for 2 valves
- [4] End block CPE...-PRS-EP
- [5] Cover plate CPE...-PRSB
- [6] H-rail to EN 50002 for mounting
- [7] Clamping screw for H-rail
- [8] Location for inscription label  
type IBS 6 x 10
- [9] Connecting component

| Size  | B1    | B2    | B3 | B4  | B5 | B6  | B7   | D1   | D2<br>∅ | H1   | H2  | H3  | H4   |
|-------|-------|-------|----|-----|----|-----|------|------|---------|------|-----|-----|------|
| CPE18 | 151.6 | 136.5 | 59 | 113 | -  | 100 | 2.75 | G1/2 | 5.3     | ~106 | ~58 | ~46 | 51.4 |

  

| Size  | L1 <sup>1)</sup> | L2 | L3 | L4 | L5   | L6   | L7 | L8  | L9 |
|-------|------------------|----|----|----|------|------|----|-----|----|
| CPE18 | 40+(n×20)+16.4   | 40 | 40 | 60 | 16.4 | 12.6 | 1  | 5.2 | 40 |

1) n = number of valve positions

Technical data – Modular manifold

| Combination options       |  |   |  |
|---------------------------|--|---|--|
| Number of valve positions | One pressure zone  | Two pressure zones  |  |
|                           |  | Variant 1   | Variant 2  |
| 2                         | 1x CPE...-PRSG-2   | –   | –  |
| 3                         | 1x CPE...-PRSG-3   | –   | –  |
| 4                         | 1x CPE...-PRSGO-2<br>1x CPE...-PRSE-2                      | 1x CPE...-PRSG-2<br>1x CPE...-PRSEO-2<br>1x CPE...-PRS-EP | –  |
| 5                         | 1x CPE...-PRSGO-3<br>1x CPE...-PRSE-2                      | 1x CPE...-PRSG-3<br>1x CPE...-PRSEO-2<br>1x CPE...-PRS-EP | –  |
| 6                         | 1x CPE...-PRSGO-2<br>1x CPE...-PRSEO-2<br>1x CPE...-PRSE-2 | 1x CPE...-PRSG-2<br>2x CPE...-PRSEO-2<br>1x CPE...-PRS-EP | 1x CPE...-PRSGO-2<br>1x CPE...-PRSE-2<br>1x CPE...-PRSEO-2<br>1x CPE...-PRS-EP |
| 7                         | 1x CPE...-PRSGO-3<br>2x CPE...-PRSEO-2<br>1x CPE...-PRS-EP | 1x CPE...-PRSG-3<br>2x CPE...-PRSEO-2<br>1x CPE...-PRS-EP | 1x CPE...-PRSGO-3<br>1x CPE...-PRSE-2<br>1x CPE...-PRSEO-2<br>1x CPE...-PRS-EP |
| 8                         | 1x CPE...-PRSGO-2<br>3x CPE...-PRSEO-2<br>1x CPE...-PRS-EP | 1x CPE...-PRSG-2<br>3x CPE...-PRSEO-2<br>1x CPE...-PRS-EP | 1x CPE...-PRSGO-2<br>1x CPE...-PRSE-2<br>2x CPE...-PRSEO-2<br>1x CPE...-PRS-EP |
| 9                         | 1x CPE...-PRSGO-3<br>3x CPE...-PRSEO-2<br>1x CPE...-PRS-EP | 1x CPE...-PRSG-3<br>3x CPE...-PRSEO-2<br>1x CPE...-PRS-EP | 1x CPE...-PRSGO-3<br>1x CPE...-PRSE-2<br>2x CPE...-PRSEO-2<br>1x CPE...-PRS-EP |
| 10                        | 1x CPE...-PRSGO-2<br>4x CPE...-PRSEO-2<br>1x CPE...-PRS-EP | 1x CPE...-PRSG-2<br>4x CPE...-PRSEO-2<br>1x CPE...-PRS-EP | 1x CPE...-PRSGO-2<br>1x CPE...-PRSE-2<br>3x CPE...-PRSEO-2<br>1x CPE...-PRS-EP |
| 11                        | 1x CPE...-PRSGO-3<br>4x CPE...-PRSEO-2<br>1x CPE...-PRS-EP | 1x CPE...-PRSG-3<br>4x CPE...-PRSEO-2<br>1x CPE...-PRS-EP | 1x CPE...-PRSGO-3<br>1x CPE...-PRSE-2<br>3x CPE...-PRSEO-2<br>1x CPE...-PRS-EP |
| 12                        | 1x CPE...-PRSGO-2<br>5x CPE...-PRSEO-2<br>1x CPE...-PRS-EP | 1x CPE...-PRSG-2<br>5x CPE...-PRSEO-2<br>1x CPE...-PRS-EP | 1x CPE...-PRSGO-2<br>1x CPE...-PRSE-2<br>4x CPE...-PRSEO-2<br>1x CPE...-PRS-EP |

 - **Note**

Each air supply can support a maximum of 6 valve positions. Use valve manifold blocks only in combination with 5/2- and 5/3-way valves.

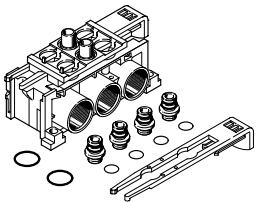
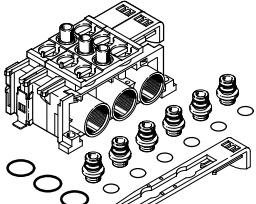
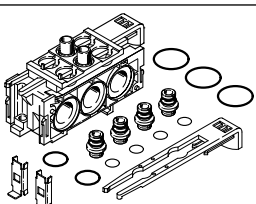
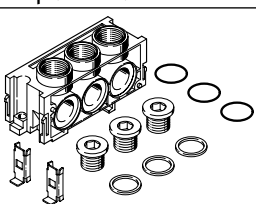
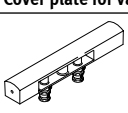

Ordering data – Modular manifold

| Ordering data   | Port 1, 3, 5 | PRS ducts | Weight [g] | Part no.      | Type                 |
|---|--------------|-----------|------------|---------------|----------------------|
| <b>Manifold block PRSG for 2 valves</b>   |              |           |            |               |                      |
|    | G1/2         | Closed    | 170        | <b>164970</b> | <b>CPE18-PRSG-2</b>  |
|   | G1/2         | Open      | 170        | <b>187831</b> | <b>CPE18-PRSGO-2</b> |
| <b>Manifold block PRSG for 3 valves</b>   |              |           |            |               |                      |
|    | G1/2         | Closed    | 225        | <b>187825</b> | <b>CPE18-PRSG-3</b>  |
|   | G1/2         | Open      | 225        | <b>187821</b> | <b>CPE18-PRSGO-3</b> |
| <b>Manifold block PRSE for 2 valves</b>   |              |           |            |               |                      |
|   | –            | Closed    | 145        | <b>164972</b> | <b>CPE18-PRSE-2</b>  |
|   | –            | Open      | 145        | <b>187832</b> | <b>CPE18-PRSEO-2</b> |
| <b>End plate for manifold</b>   |              |           |            |               |                      |
|  | G1/2         | –         | 125        | <b>164973</b> | <b>CPE18-PRS-EP</b>  |
| <b>Cover plate for vacant position</b>  |              |           |            |               |                      |
|  | –            | –         | 28         | <b>164974</b> | <b>CPE18-PRSB</b>    |

## Type codes

| 001 | Series                              |
|-----|-------------------------------------|
| CPE | Solenoid valve, Compact Performance |
| 002 | Width                               |
| 24  | 24 mm                               |
| 003 | Nominal operating voltage           |
| M1  | 24 V DC                             |
| M2  | 110 V AC                            |
| M3  | 230 V AC                            |
| 004 | Electrical connection               |
| H   | Plug pattern ZC                     |

| 005   | Valve function                          |
|-------|---|
| 5L    | 5/2-way valve, monostable               |
| 5J    | 5/2-way valve, bistable                 |
| 3GL   | 3/2-way valve, normally closed          |
| 3OL   | 3/2-way valve, normally open            |
| 5/3G  | 5/3-way valve, mid-position closed      |
| 5/3E  | 5/3-way valve, mid-position exhausted   |
| 5/3B  | 5/3-way valve, mid-position pressurised |
| 006   | Pilot air                               |
|       | Internal                                |
| S     | External                                |
| 007   | Pneumatic connection                    |
| 3/8   | G3/8                                    |
| QS-10 | Push-in connector 10 mm                 |
| QS-12 | Push-in connector 12 mm                 |



## Datasheet

### Functions:

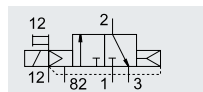
3/2G, 3/2O,  
5/2-way single solenoid  
5/2-way double pilot valve  
5/3G, 5/3B, 5/3E



3/2G with external pilot air supply, normally closed

-  - Width 24 mm
-  - Flow rate  
1250 ... 3200 l/min
-  - Voltage  
24 V DC, 110, 230 V AC  
basic valve  
12, 24 V DC,  
24, 110, 230 V AC



| General technical data                                     |              | 3/2   |                 | 5/2                                       |       | 5/3             |                 |                 |
|--|--------------|---|-----------------|---|-------|-----------------|-----------------|-----------------|
| Valve function   |              | G <sup>1)</sup>   | O <sup>2)</sup> | -   | -     | G <sup>1)</sup> | B <sup>2)</sup> | E <sup>3)</sup> |
| Normal position  |              | Monostable  |                 | Bistable                                  |       | Monostable      |                 |                 |
| Stable position  |              | Yes   |                 | -   |       | No              |                 |                 |
| Pneumatic spring reset                                     |              | No  |                 | -   |       | Yes             |                 |                 |
| Mechanical spring reset                                    |              | Piston spool  |                 |   |       |                 |                 |                 |
| Design   |              | Soft  |                 |   |       |                 |                 |                 |
| Sealing principle  |              | Positive overlap  |                 |   |       |                 |                 |                 |
| Overlap  |              | Electrical  |                 |   |       |                 |                 |                 |
| Actuation type   |              | Piloted   |                 |   |       |                 |                 |                 |
| Type of control  |              | Internal or external  |                 |   |       |                 |                 |                 |
| Pilot air supply   |              | -   |                 | Reversible with external pilot air supply |       |                 |                 |                 |
| Flow direction   |              |   |                 | Can be throttled                          |       |                 |                 |                 |
| Exhaust function   |              | Non-detenting, detenting via accessory  |                 |   |       |                 |                 |                 |
| Manual override  |              | Via through-holes   |                 |   |       |                 |                 |                 |
| Type of mounting   |              | Any   |                 |   |       |                 |                 |                 |
| Mounting position  |              | Threaded connection: G3/8, QS connection: $\varnothing$ 10 or $\varnothing$ 12 mm |                 |   |       |                 |                 |                 |
| Pneumatic connection                                       | 1, 2, 4      | Threaded connection: G3/8   |                 |   |       |                 |                 |                 |
|  | 3, 5         | Threaded connection: G3/8   |                 |   |       |                 |                 |                 |
|  | 12, 14       | Threaded connection: M5, QS connection: $\varnothing$ 6 mm                        |                 |   |       |                 |                 |                 |
|  | 82, 84       | Threaded connection: M5   |                 |   |       |                 |                 |                 |
| Nominal width  | [mm]         | 11  |                 |   |       |                 |                 |                 |
| Standard nominal flow rate                                 | G3/8 [l/min] | 2500  | 2900            | 3200                                      | 3000  | 2600            | 2650            |                 |
|  | QS10 [l/min] | 1250  |                 |   |       |                 |                 |                 |
|  | QS12 [l/min] | 1650  |                 |   |       |                 |                 |                 |
| Switching time   | On/Off [ms]  | 50/33   | 40/50           | -   | 25/55 |                 |                 |                 |
|  | Reverse [ms] | -   | -               | 25  | -     |                 |                 |                 |
| Duty cycle   | [%]          | 100   |                 |   |       |                 |                 |                 |
| Width  | [mm]         | 24  |                 |   |       |                 |                 |                 |
| Corrosion resistance class CRC <sup>4)</sup>               |              | 2   |                 |   |       |                 |                 |                 |
| CE marking (see declaration of conformity) <sup>5)</sup>   |              | To EU Low Voltage Directive <sup>6)</sup>   |                 |   |       |                 |                 |                 |
| UKCA marking (see declaration of conformity) <sup>5)</sup> |              | To UK regulations for electrical equipment <sup>6)</sup>                          |                 |   |       |                 |                 |                 |

1) G = normally closed

2) O, B = normally open

3) E = normally exhausted

4) Corrosion resistance class CRC 2 to Festo standard FN 940070

Moderate corrosion stress. Indoor applications in which condensation can occur. External visible parts with primarily decorative surface requirements which are in direct contact with a normal industrial environment.

5) For information about the area of use, see the EC declaration of conformity at: [www.festo.com/catalogue/...](http://www.festo.com/catalogue/...) → Support/Downloads.

If the devices are subject to usage restrictions in residential, commercial or light-industrial environments, further measures for the reduction of the emitted interference may be necessary.

6) Only for CPE24-M2H... and CPE24-M3H...

## Datasheet

| Operating and environmental conditions |                           |       | 3/2  | 5/2-way, single solenoid | 5/2-way, double solenoid | 5/3 |
|--|---------------------------|-------|--|--------------------------|--------------------------|-----|
| Valve function                         |                           |       | 3/2  | 5/2-way, single solenoid | 5/2-way, double solenoid | 5/3 |
| Operating medium                       |                           |       | Compressed air to ISO 8573-1:2010 [7:4:4]  |                          |                          |     |
| Pilot medium                           |                           |       | Compressed air to ISO 8573-1:2010 [7:4:4]  |                          |                          |     |
| Note on the operating/pilot medium     |                           |       | Lubricated operation possible (in which case lubricated operation will always be required) |                          |                          |     |
| Operating pressure                     | Internal pilot air supply | [MPa] | 0.25 ... 1   | 0.2 ... 1                | 0.25 ... 1               |     |
|  |                           | [bar] | 2.5 ... 10   | 2 ... 10                 | 2.5 ... 10               |     |
|  | External pilot air supply | [MPa] | -0.09 ... 1  |                          |                          |     |
|  |                           | [bar] | -0.9 ... 10  |                          |                          |     |
| Pilot pressure                         |                           | [MPa] | 0.25 ... 1   | 0.2 ... 1                | 0.25 ... 1               |     |
|  |                           | [bar] | 2.5 ... 10   | 2 ... 10                 | 2.5 ... 10               |     |
| Ambient temperature                    |                           | [°C]  | -5 ... +50   |                          |                          |     |
| Temperature of medium                  |                           | [°C]  | -5 ... +50   |                          |                          |     |
| Certification                          |                           |       | c UL us - Recognized (OL)  |                          |                          |     |
| Maritime classification <sup>1)</sup>  |                           |       | See certificate  |                          |                          |     |

1) Additional information: [www.festo.com/sp](http://www.festo.com/sp) → Certificates.

| Electrical data                       |          |        |                            |
|---------------------------------------|----------|--------|----------------------------|
| Operating voltage                     | M1H      | [V DC] | 24 +10/-15%                |
|                                       | M2H      | [V AC] | 110 ±10% with 50 ... 60 Hz |
|                                       | M3H      | [V AC] | 230 ±10% with 50 ... 60 Hz |
| Power consumption                     | M1H      | [W]    | 1.5                        |
|                                       | M2H, M3H | [VA]   | Pull: 3, hold: 2.4         |
| Degree of protection with plug socket |          |        | IP65 to IEC 60529          |

### Materials

Sectional view

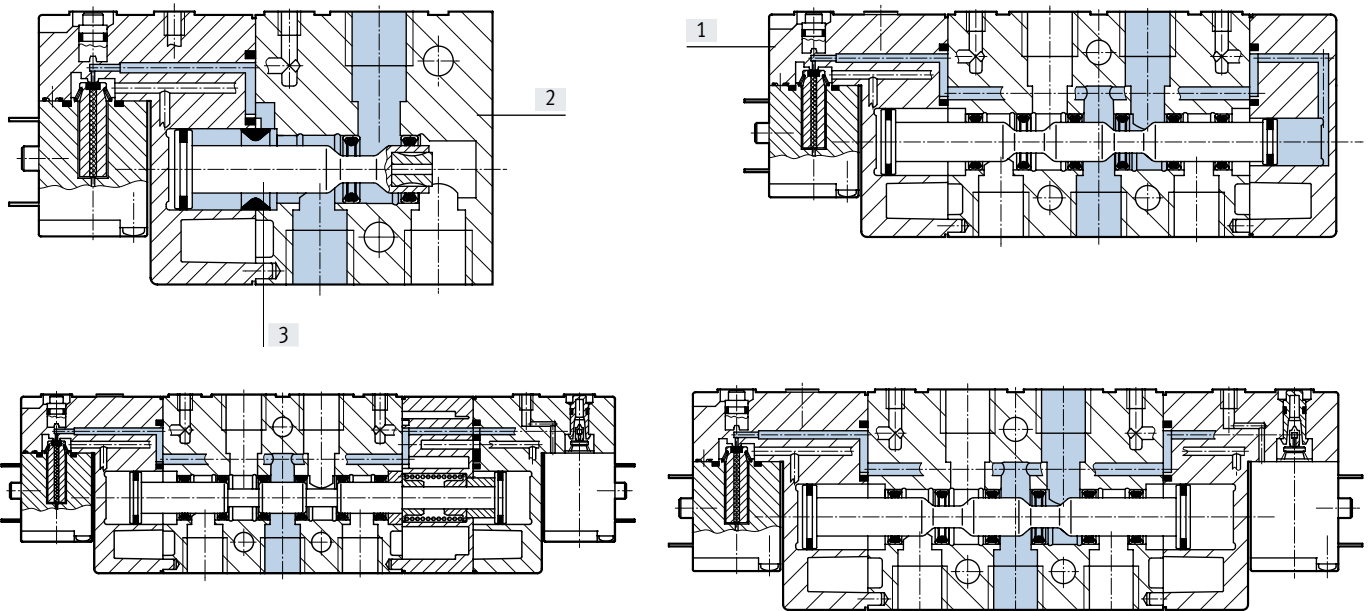

|     |                   |                    |
|-----|-------------------|--------------------|
| [1] | Cover             | PA                 |
| [2] | Housing           | Die-cast aluminium |
| [3] | Piston spool      | Steel              |
| -   | Seals             | NBR                |
|     | Note on materials | RoHS-compliant     |

Datasheet

Dimensions – 3/2-way valve

Download CAD data → [www.festo.com](http://www.festo.com)

CPE24-...-3/8

CPE24-...-QS-10

CPE24-...-QS-12

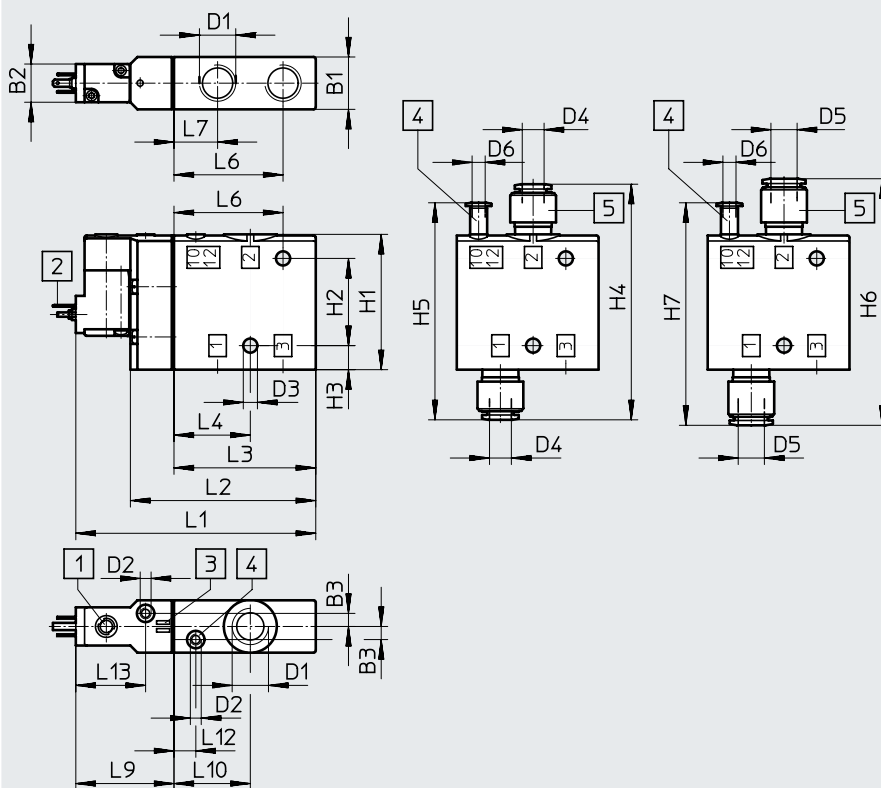

[1] Manual override  
[2] Plug type C, to EN 175301-803

[3] Space for inscription labels

[4] Port 10/12 for external pilot air supply

[5] QS push-in fitting

| Type           | B1<br>±0.1 | B2<br>-0.5 | B3 | D1   | D2 | D3<br>∅ | D4<br>∅ | D5<br>∅ | D6<br>∅ | H1<br>±0.25 | H2 | H3<br>±0.1 | H4  | H5   | H6  | H7  |
|----------------|------------|------------|----|------|----|---------|---------|---------|---------|-------------|----|------------|-----|------|-----|-----|
| CPE24-M1H-3... | 24         | 17.5       | 6  | G3/8 | M5 | 6.5     | 10      | 12      | 6       | 62          | 40 | 11         | 108 | 99.5 | 113 | 102 |

| Type            | L1  | L2 | L3<br>±0.2 | L4<br>±0.12 | L6<br>±0.15 | L7<br>±0.12 | L9 | L10 | L12<br>±0.12 | L13 |
|-----------------|-----|----|------------|-------------|-------------|-------------|----|-----|--------------|-----|
| CPE124-M1H-3... | 110 | 85 | 65         | 35          | 50          | 20          | 45 | 35  | 10           | 32  |

Datasheet

Dimensions – 5/2-way single solenoid valve

Download CAD data → [www.festo.com](http://www.festo.com)

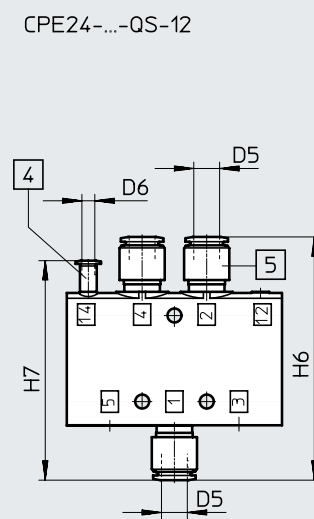
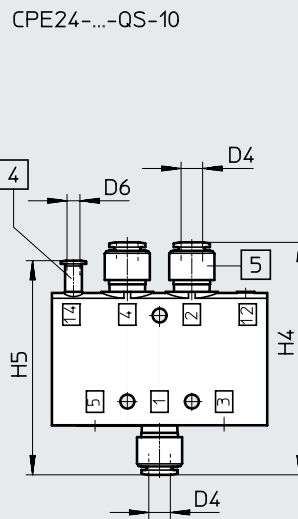
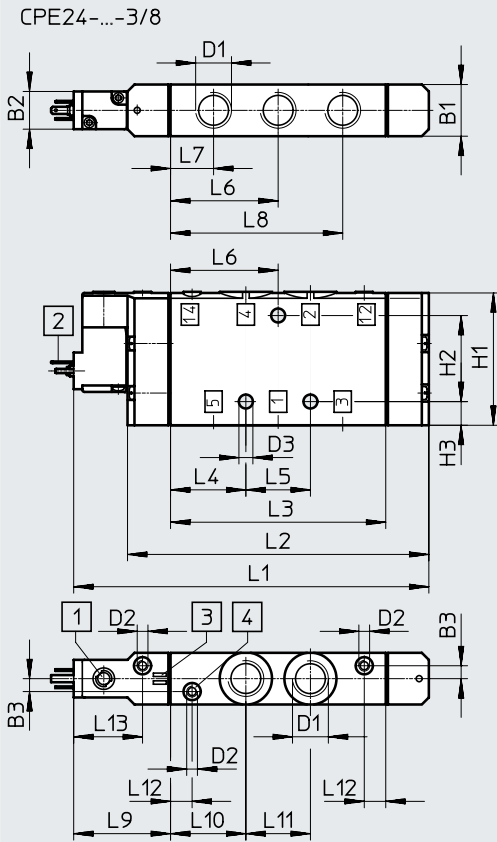

- [1] Manual override
- [2] Plug type C, to EN 175301-803
- [3] Space for inscription labels
- [4] Port 12/14 for external pilot air supply
- [5] QS push-in fitting

| Type            | B1 | B2   | B3 | D1   | D2 | D3<br>∅ | D4<br>∅ | D5<br>∅ | D6<br>∅ | H1 | H2 | H3 | H4  | H5   | H6  | H7  |
|-----------------|----|------|----|------|----|---------|---------|---------|---------|----|----|----|-----|------|-----|-----|
| CPE24-M1H-5L... | 24 | 17.5 | 6  | G3/8 | M5 | 6.5     | 10      | 12      | 6       | 62 | 40 | 11 | 108 | 99.5 | 113 | 102 |

| Type            | L1  | L2  | L3  | L4 | L5 | L6 | L7 | L8 | L9 | L10 | L11 | L12 | L13 |
|-----------------|-----|-----|-----|----|----|----|----|----|----|-----|-----|-----|-----|
| CPE24-M1H-5L... | 165 | 140 | 100 | 35 | 30 | 50 | 20 | 80 | 45 | 35  | 30  | 10  | 32  |

Datasheet

Dimensions – 5/2-way double solenoid valve

Download CAD data → [www.festo.com](http://www.festo.com)

Threaded connection

Push-in connector

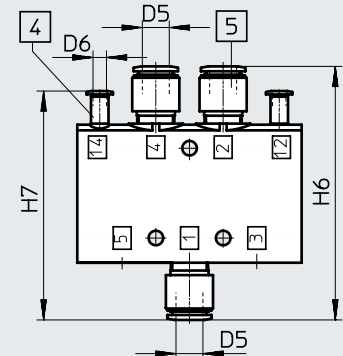
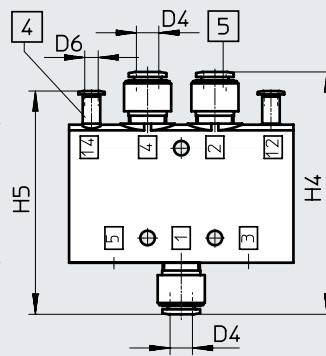
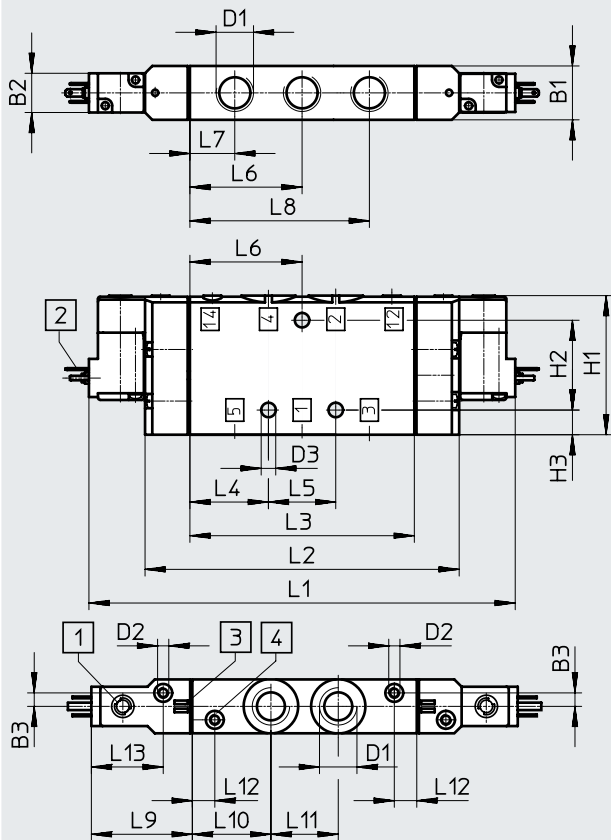

- [1] Manual override
- [2] Plug type C, to EN 175301-803
- [3] Space for inscription labels
- [4] Port 12/14 for external pilot air supply
- [5] QS push-in fitting

| Type             | B1 | B2   | B3 | D1   | D2 | D3<br>∅ | D4<br>∅ | D5<br>∅ | D6<br>∅ | H1 | H2 | H3 | H4  | H5   | H6  | H7  |
|------------------|----|------|----|------|----|---------|---------|---------|---------|----|----|----|-----|------|-----|-----|
| CPE24-...-5)-3/8 | 24 | 17.5 | 6  | G3/8 | M5 | 6.5     | 10      | 12      | 6       | 62 | 40 | 11 | 108 | 99.5 | 113 | 102 |

| Type             | L1  | L2  | L3  | L4 | L5 | L6 | L7 | L8 | L9 | L10 | L11 | L12 | L13 |
|------------------|-----|-----|-----|----|----|----|----|----|----|-----|-----|-----|-----|
| CPE24-...-5)-3/8 | 190 | 140 | 100 | 35 | 30 | 50 | 20 | 80 | 45 | 35  | 30  | 10  | 32  |

Datasheet

Dimensions – 5/3-way valve

Download CAD data → [www.festo.com](http://www.festo.com)

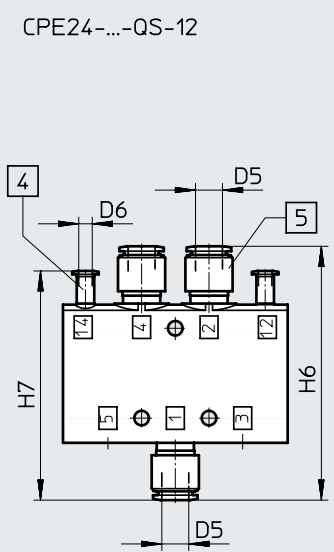
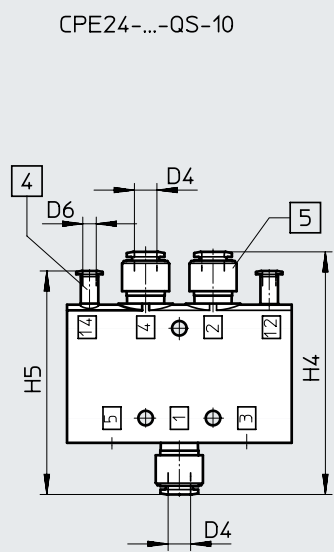
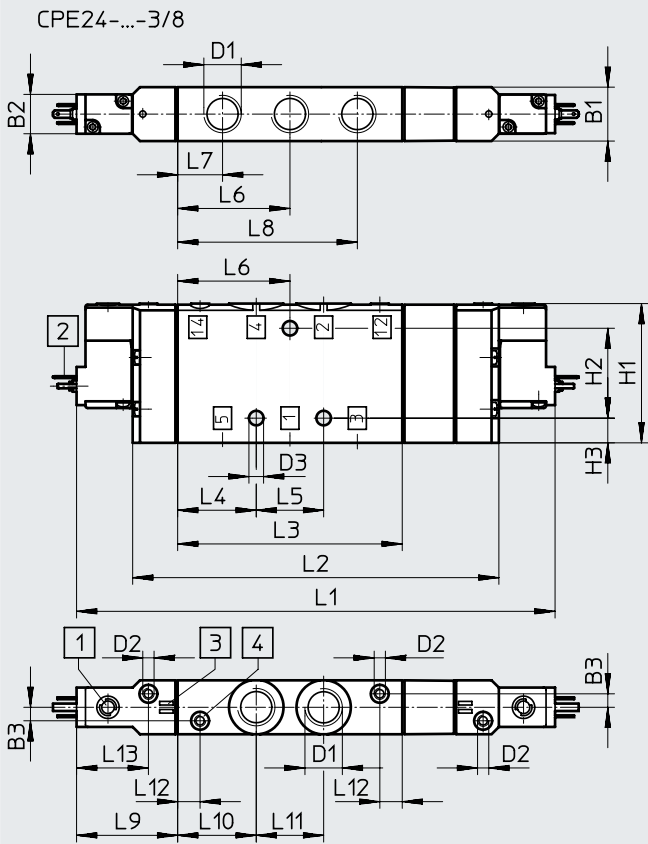

- [1] Manual override
- [2] Plug type C, to EN 175301-803
- [3] Space for inscription labels
- [4] Port 12/14 for external pilot air supply
- [5] QS push-in fitting

| Type             | B1<br>±0.1 | B2<br>-0.5 | B3 | D1   | D2 | D3<br>∅ | D4<br>∅ | D5<br>∅ | D6<br>∅ | H1<br>±0.25 | H2 | H3<br>±0.1 | H4  | H5   | H6  | H7  |
|------------------|------------|------------|----|------|----|---------|---------|---------|---------|-------------|----|------------|-----|------|-----|-----|
| CPE24-M1H...-5   | 24         | 17.5       | 6  | G3/8 | M5 | 6.5     | 10      | 12      | 6       | 62          | 40 | 11         | 108 | 99.5 | 113 | 102 |
| CPE24-M1H...-5/3 |            |            |    |      |    |         |         |         |         |             |    |            |     |      |     |     |

| Type             | L1  | L2  | L3<br>±0.2 | L4<br>±0.2 | L5 | L6 | L7<br>±0.12 | L8<br>±0.2 | L9 | L10<br>±0.12 | L11 | L12<br>±0.12 | L13 |
|------------------|-----|-----|------------|------------|----|----|-------------|------------|----|--------------|-----|--------------|-----|
| CPE24-M1H...-5J  | 190 | 140 | 100        | 35         | 30 | 50 | 20          | 80         | 45 | 35           | 30  | 10           | 32  |
| CPE24-M1H...-5/3 | 213 | 163 |            |            |    |    |             |            |    |              |     |              |     |

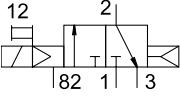
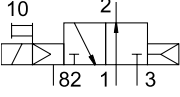
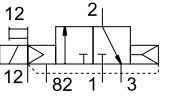
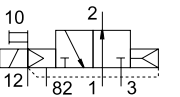

## Ordering data – 3/2-way valve

| Ordering data   |                  |          |                      |            |          |                      |
|---|------------------|----------|----------------------|------------|----------|----------------------|
| Circuit symbol  | Pilot air supply | Voltage  | Pneumatic connection | Weight [g] | Part no. | Type                 |
| <b>Normally closed</b>  |                  |          |                      |            |          |                      |
|    | Internal         | 24 V DC  | G3/8                 | 220        | 163165   | CPE24-M1H-3GL-3/8    |
|   |                  |          | QS-10                | –          | 163173   | CPE24-M1H-3GL-QS-10  |
|   |                  |          | QS-12                | –          | 163181   | CPE24-M1H-3GL-QS-12  |
|   |                  | 110 V AC | G3/8                 | 220        | 163809   | CPE24-M2H-3GL-3/8    |
|   |                  |          | QS-10                | –          | 163817   | CPE24-M2H-3GL-QS-10  |
|   |                  |          | QS-12                | –          | 163825   | CPE24-M2H-3GL-QS-12  |
|   |                  | 230 V AC | G3/8                 | 220        | 163833   | CPE24-M3H-3GL-3/8    |
|   |                  |          | QS-10                | –          | 163841   | CPE24-M3H-3GL-QS-10  |
|   |                  |          | QS-12                | –          | 163849   | CPE24-M3H-3GL-QS-12  |
| <b>Normally open</b>  |                  |          |                      |            |          |                      |
|    | Internal         | 24 V DC  | G3/8                 | 220        | 163164   | CPE24-M1H-3OL-3/8    |
|   |                  |          | QS-10                | –          | 163172   | CPE24-M1H-3OL-QS-10  |
|   |                  |          | QS-12                | –          | 163180   | CPE24-M1H-3OL-QS-12  |
|   |                  | 110 V AC | G3/8                 | 220        | 163808   | CPE24-M2H-3OL-3/8    |
|   |                  |          | QS-10                | –          | 163816   | CPE24-M2H-3OL-QS-10  |
|   |                  |          | QS-12                | –          | 163824   | CPE24-M2H-3OL-QS-12  |
|   |                  | 230 V AC | G3/8                 | 220        | 163832   | CPE24-M3H-3OL-3/8    |
|   |                  |          | QS-10                | –          | 163840   | CPE24-M3H-3OL-QS-10  |
|   |                  |          | QS-12                | –          | 163848   | CPE24-M3H-3OL-QS-12  |
| <b>Normally closed</b>  |                  |          |                      |            |          |                      |
|   | External         | 24 V DC  | G3/8                 | 220        | 163169   | CPE24-M1H-3GLS-3/8   |
|   |                  |          | QS-10                | –          | 163177   | CPE24-M1H-3GLS-QS-10 |
|   |                  |          | QS-12                | –          | 163185   | CPE24-M1H-3GLS-QS-12 |
|   |                  | 110 V AC | G3/8                 | 220        | 163813   | CPE24-M2H-3GLS-3/8   |
|   |                  |          | QS-10                | –          | 163821   | CPE24-M2H-3GLS-QS-10 |
|   |                  |          | QS-12                | –          | 163829   | CPE24-M2H-3GLS-QS-12 |
|   |                  | 230 V AC | G3/8                 | 220        | 163837   | CPE24-M3H-3GLS-3/8   |
|   |                  |          | QS-10                | –          | 163845   | CPE24-M3H-3GLS-QS-10 |
|   |                  |          | QS-12                | –          | 163853   | CPE24-M3H-3GLS-QS-12 |
| <b>Normally open</b>  |                  |          |                      |            |          |                      |
|  | External         | 24 V DC  | G3/8                 | 220        | 163168   | CPE24-M1H-3OLS-3/8   |
|   |                  |          | QS-10                | –          | 163176   | CPE24-M1H-3OLS-QS-10 |
|   |                  |          | QS-12                | –          | 163184   | CPE24-M1H-3OLS-QS-12 |
|   |                  | 110 V AC | G3/8                 | 220        | 163812   | CPE24-M2H-3OLS-3/8   |
|   |                  |          | QS-10                | –          | 163820   | CPE24-M2H-3OLS-QS-10 |
|   |                  |          | QS-12                | –          | 163828   | CPE24-M2H-3OLS-QS-12 |
|   |                  | 230 V AC | G3/8                 | 220        | 163836   | CPE24-M3H-3OLS-3/8   |
|   |                  |          | QS-10                | –          | 163844   | CPE24-M3H-3OLS-QS-10 |
|   |                  |          | QS-12                | –          | 163852   | CPE24-M3H-3OLS-QS-12 |

Ordering data – 5/2-way valve

| Ordering data<br>Circuit symbol       | Pilot air supply | Voltage  | Pneumatic<br>connection | Weight<br>[g] | Part no. | Type                |
|---------------------------------------|------------------|----------|-------------------------|---------------|----------|---------------------|
| <b>5/2-way valve, single solenoid</b> |                  |          |                         |               |          |                     |
|                                       | Internal         | 24 V DC  | G3/8                    | 360           | 163166   | CPE24-M1H-5L-3/8    |
|                                       |                  |          | QS-10                   | –             | 163174   | CPE24-M1H-5L-QS-10  |
|                                       |                  |          | QS-12                   | –             | 163182   | CPE24-M1H-5L-QS-12  |
|                                       |                  | 110 V AC | G3/8                    | 360           | 163810   | CPE24-M2H-5L-3/8    |
|                                       |                  |          | QS-10                   | –             | 163818   | CPE24-M2H-5L-QS-10  |
|                                       |                  |          | QS-12                   | –             | 163826   | CPE24-M2H-5L-QS-12  |
|                                       |                  | 230 V AC | G3/8                    | 360           | 163834   | CPE24-M3H-5L-3/8    |
|                                       |                  |          | QS-10                   | –             | 163842   | CPE24-M3H-5L-QS-10  |
|                                       |                  |          | QS-12                   | –             | 163850   | CPE24-M3H-5L-QS-12  |
| <b>5/2-way double pilot valve</b>     |                  |          |                         |               |          |                     |
|                                       | Internal         | 24 V DC  | G3/8                    | 390           | 163167   | CPE24-M1H-5J-3/8    |
|                                       |                  |          | QS-10                   | –             | 163175   | CPE24-M1H-5J-QS-10  |
|                                       |                  |          | QS-12                   | –             | 163183   | CPE24-M1H-5J-QS-12  |
|                                       |                  | 110 V AC | G3/8                    | 390           | 163811   | CPE24-M2H-5J-3/8    |
|                                       |                  |          | QS-10                   | –             | 163819   | CPE24-M2H-5J-QS-10  |
|                                       |                  |          | QS-12                   | –             | 163827   | CPE24-M2H-5J-QS-12  |
|                                       |                  | 230 V AC | G3/8                    | 390           | 163835   | CPE24-M3H-5J-3/8    |
|                                       |                  |          | QS-10                   | –             | 163843   | CPE24-M3H-5J-QS-10  |
|                                       |                  |          | QS-12                   | –             | 163851   | CPE24-M3H-5J-QS-12  |
| <b>5/2-way valve, single solenoid</b> |                  |          |                         |               |          |                     |
|                                       | External         | 24 V DC  | G3/8                    | 360           | 163170   | CPE24-M1H-5LS-3/8   |
|                                       |                  |          | QS-10                   | –             | 163178   | CPE24-M1H-5LS-QS-10 |
|                                       |                  |          | QS-12                   | –             | 163186   | CPE24-M1H-5LS-QS-12 |
|                                       |                  | 110 V AC | G3/8                    | 360           | 163814   | CPE24-M2H-5LS-3/8   |
|                                       |                  |          | QS-10                   | –             | 163822   | CPE24-M2H-5LS-QS-10 |
|                                       |                  |          | QS-12                   | –             | 163830   | CPE24-M2H-5LS-QS-12 |
|                                       |                  | 230 V AC | G3/8                    | 360           | 163838   | CPE24-M3H-5LS-3/8   |
|                                       |                  |          | QS-10                   | –             | 163846   | CPE24-M3H-5LS-QS-10 |
|                                       |                  |          | QS-12                   | –             | 163854   | CPE24-M3H-5LS-QS-12 |
| <b>5/2-way double pilot valve</b>     |                  |          |                         |               |          |                     |
|                                       | External         | 24 V DC  | G3/8                    | 390           | 163171   | CPE24-M1H-5JS-3/8   |
|                                       |                  |          | QS-10                   | –             | 163179   | CPE24-M1H-5JS-QS-10 |
|                                       |                  |          | QS-12                   | –             | 163187   | CPE24-M1H-5JS-QS-12 |
|                                       |                  | 110 V AC | G3/8                    | 390           | 163815   | CPE24-M2H-5JS-3/8   |
|                                       |                  |          | QS-10                   | –             | 163823   | CPE24-M2H-5JS-QS-10 |
|                                       |                  |          | QS-12                   | –             | 163831   | CPE24-M2H-5JS-QS-12 |
|                                       |                  | 230 V AC | G3/8                    | 390           | 163839   | CPE24-M3H-5JS-3/8   |
|                                       |                  |          | QS-10                   | –             | 163847   | CPE24-M3H-5JS-QS-10 |
|                                       |                  |          | QS-12                   | –             | 163855   | CPE24-M3H-5JS-QS-12 |



## Ordering data – 5/3-way valve

| Ordering data   |                  |          |                      |            |          |                      |
|---|------------------|----------|----------------------|------------|----------|----------------------|
| Circuit symbol  | Pilot air supply | Voltage  | Pneumatic connection | Weight [g] | Part no. | Type                 |
| <b>5/3-way mid-position valve, normally closed</b>    |                  |          |                      |            |          |                      |
|   | Internal         | 24 V DC  | G3/8                 | 430        | 170265   | CPE24-M1H-5/3G-3/8   |
|   |                  |          | QS-10                | –          | 170271   | CPE24-M1H-5/3G-QS-10 |
|   |                  |          | QS-12                | –          | 170277   | CPE24-M1H-5/3G-QS-12 |
|   |                  | 110 V AC | G3/8                 | 430        | 170301   | CPE24-M2H-5/3G-3/8   |
|   |                  |          | QS-10                | –          | 170307   | CPE24-M2H-5/3G-QS-10 |
|   |                  |          | QS-12                | –          | 170313   | CPE24-M2H-5/3G-QS-12 |
|   |                  | 230 V AC | G3/8                 | 430        | 170337   | CPE24-M3H-5/3G-3/8   |
|   |                  |          | QS-10                | –          | 170343   | CPE24-M3H-5/3G-QS-10 |
|   |                  |          | QS-12                | –          | 170349   | CPE24-M3H-5/3G-QS-12 |
| <b>5/3-way mid-position valve, normally exhausted</b> |                  |          |                      |            |          |                      |
|   | Internal         | 24 V DC  | G3/8                 | 430        | 170267   | CPE24-M1H-5/3E-3/8   |
|   |                  |          | QS-10                | –          | 170273   | CPE24-M1H-5/3E-QS-10 |
|   |                  |          | QS-12                | –          | 170279   | CPE24-M1H-5/3E-QS-12 |
|   |                  | 110 V AC | G3/8                 | 430        | 170303   | CPE24-M2H-5/3E-3/8   |
|   |                  |          | QS-10                | –          | 170309   | CPE24-M2H-5/3E-QS-10 |
|   |                  |          | QS-12                | –          | 170315   | CPE24-M2H-5/3E-QS-12 |
|   |                  | 230 V AC | G3/8                 | 430        | 170339   | CPE24-M3H-5/3E-3/8   |
|   |                  |          | QS-10                | –          | 170345   | CPE24-M3H-5/3E-QS-10 |
|   |                  |          | QS-12                | –          | 170351   | CPE24-M3H-5/3E-QS-12 |
| <b>5/3-way mid-position valve, normally open</b>      |                  |          |                      |            |          |                      |
|   | Internal         | 24 V DC  | G3/8                 | 430        | 170269   | CPE24-M1H-5/3B-3/8   |
|   |                  |          | QS-10                | –          | 170275   | CPE24-M1H-5/3B-QS-10 |
|   |                  |          | QS-12                | –          | 170281   | CPE24-M1H-5/3B-QS-12 |
|   |                  | 110 V AC | G3/8                 | 430        | 170305   | CPE24-M2H-5/3B-3/8   |
|   |                  |          | QS-10                | –          | 170311   | CPE24-M2H-5/3B-QS-10 |
|   |                  |          | QS-12                | –          | 170317   | CPE24-M2H-5/3B-QS-12 |
|   |                  | 230 V AC | G3/8                 | 430        | 170341   | CPE24-M3H-5/3B-3/8   |
|   |                  |          | QS-10                | –          | 170347   | CPE24-M3H-5/3B-QS-10 |
|   |                  |          | QS-12                | –          | 170353   | CPE24-M3H-5/3B-QS-12 |





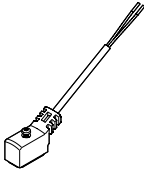
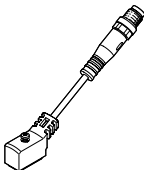
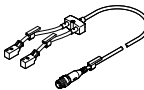

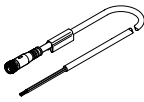

## Ordering data – 5/3-way valves

| Ordering data – 5/3-way valve<br>Circuit symbol       | Pilot air supply | Voltage  | Pneumatic<br>connection | Weight<br>[g] | Part no.      | Type                  |
|---|------------------|----------|-------------------------|---------------|---------------|-----------------------|
| <b>5/3-way mid-position valve, normally closed</b>    |                  |          |                         |               |               |                       |
|   | External         | 24 V DC  | G3/8                    | 430           | <b>170266</b> | CPE24-M1H-5/3GS-3/8   |
|   |                  |          | QS-10                   | –             | <b>170272</b> | CPE24-M1H-5/3GS-QS-10 |
|   |                  |          | QS-12                   | –             | <b>170278</b> | CPE24-M1H-5/3GS-QS-12 |
|   |                  | 110 V AC | G3/8                    | 430           | <b>170302</b> | CPE24-M2H-5/3GS-3/8   |
|   |                  |          | QS-10                   | –             | <b>170308</b> | CPE24-M2H-5/3GS-QS-10 |
|   |                  |          | QS-12                   | –             | <b>170314</b> | CPE24-M2H-5/3GS-QS-12 |
|   |                  | 230 V AC | G3/8                    | 430           | <b>170338</b> | CPE24-M3H-5/3GS-3/8   |
|   |                  |          | QS-10                   | –             | <b>170344</b> | CPE24-M3H-5/3GS-QS-10 |
|   |                  |          | QS-12                   | –             | <b>170350</b> | CPE24-M3H-5/3GS-QS-12 |
| <b>5/3-way mid-position valve, normally exhausted</b> |                  |          |                         |               |               |                       |
|   | External         | 24 V DC  | G3/8                    | 430           | <b>170268</b> | CPE24-M1H-5/3ES-3/8   |
|   |                  |          | QS-10                   | –             | <b>170274</b> | CPE24-M1H-5/3ES-QS-10 |
|   |                  |          | QS-12                   | –             | <b>170280</b> | CPE24-M1H-5/3ES-QS-12 |
|   |                  | 110 V AC | G3/8                    | 430           | <b>170304</b> | CPE24-M2H-5/3ES-3/8   |
|   |                  |          | QS-10                   | –             | <b>170310</b> | CPE24-M2H-5/3ES-QS-10 |
|   |                  |          | QS-12                   | –             | <b>170316</b> | CPE24-M2H-5/3ES-QS-12 |
|   |                  | 230 V AC | G3/8                    | 430           | <b>170340</b> | CPE24-M3H-5/3ES-3/8   |
|   |                  |          | QS-10                   | –             | <b>170346</b> | CPE24-M3H-5/3ES-QS-10 |
|   |                  |          | QS-12                   | –             | <b>170352</b> | CPE24-M3H-5/3ES-QS-12 |
| <b>5/3-way mid-position valve, normally open</b>      |                  |          |                         |               |               |                       |
|   | External         | 24 V DC  | G3/8                    | 430           | <b>170270</b> | CPE24-M1H-5/3BS-3/8   |
|   |                  |          | QS-10                   | –             | <b>170276</b> | CPE24-M1H-5/3BS-QS-10 |
|   |                  |          | QS-12                   | –             | <b>170282</b> | CPE24-M1H-5/3BS-QS-12 |
|   |                  | 110 V AC | G3/8                    | 430           | <b>170306</b> | CPE24-M2H-5/3BS-3/8   |
|   |                  |          | QS-10                   | –             | <b>170312</b> | CPE24-M2H-5/3BS-QS-10 |
|   |                  |          | QS-12                   | –             | <b>170318</b> | CPE24-M2H-5/3BS-QS-12 |
|   |                  | 230 V AC | G3/8                    | 430           | <b>170342</b> | CPE24-M3H-5/3BS-3/8   |
|   |                  |          | QS-10                   | –             | <b>170348</b> | CPE24-M3H-5/3BS-QS-10 |
|   |                  |          | QS-12                   | –             | <b>170354</b> | CPE24-M3H-5/3BS-QS-12 |

## Accessories

| Ordering data – Accessories for CPE10 and CPE14                                     |  |  |  |                            | Part no.                    | Type                                       |
|---|--|--|--|----------------------------|-----------------------------|--|
| <b>Connecting cable, socket plug pattern ZC</b>                                     |  |  |  |                            | Datasheets → Internet: nebv |  |
|    | Open cable end 2-wire                            | PUR cable, degree of protection IP65   | Holding current reduction, protective circuit, signal status indication with LED | Length 2.5 m               | <b>8047679</b>              | <b>NEBV-Z4WA2L-R-E-2.5-N-LE2-S1</b>        |
|   |  |  |  | Length 5 m                 | <b>8047680</b>              | <b>NEBV-Z4WA2L-R-E-5-N-LE2-S1</b>          |
|   |  |  |  | Length 10 m                | <b>8047678</b>              | <b>NEBV-Z4WA2L-R-E-10-N-LE2-S1</b>         |
|   | PVC cable, degree of protection IP40             | Without signal status indication   | Length 0.5 m   | <b>193690</b>              | <b>KMYZ-4-24-0.5-B</b>      |  |
|   |  |  | Length 2.5 m   | <b>193691</b>              | <b>KMYZ-4-24-2.5-B</b>      |  |
|    | Plug M8x1 3-pin                                  | PUR cable, degree of protection IP65   | Holding current reduction, protective circuit, signal status indication with LED | Length 0.5 m               | <b>8047683</b>              | <b>NEBV-Z4WA2L-R-E-0.5-N-M8G3-S1</b>       |
|   |  |  |  | Length 2.5 m               | <b>8047684</b>              | <b>NEBV-Z4WA2L-R-E-2.5-N-M8G3-S1</b>       |
| <b>2 to 1 distributor</b>   |  |  |  |                            | Datasheet → Internet: neby  |  |
|    | 2x plug socket plug pattern ZC                   | Holding current reduction, protective circuit, signal status indication with LED | 1x plug, straight, M8x1  | Length 2.8 m               | <b>8035789</b>              | <b>NEDY-L2R1-V1-Z4W2Z-U-0.3L-M8G4-2.5R</b> |
|   |  |  |  | Length 5.3 m               | <b>8035790</b>              | <b>NEDY-L2R1-V1-Z4W2Z-U-0.3L-M8G4-5R</b>   |
|   |  |  | 1x plug, straight, M12x1   | Length 2.8 m               | <b>8035787</b>              | <b>NEDY-L2R1-V1-Z4W2Z-U-0.3L-M8G4-2.5R</b> |
|   |  |  |  | Length 5.3 m               | <b>8035788</b>              | <b>NEDY-L2R1-V1-Z4W2Z-U-0.3L-M12G4-5R</b>  |
|   | Modular system for any 2 to 1 distributor        |  |  | Length 0.3 ... 30 m        | <b>8032867</b>              | <b>NEDY-...</b><br>→ Internet: nedy        |
| <b>Adapter</b>  |  |  |  |                            |                             |  |
|   | Plug socket, plug pattern ZC                     | Signal status indication with LED  | Plug M8, 3-pin   | <b>571686</b>              | <b>VAVE-C8-1R8</b>          |  |
|   |  |  | Plug M8, 4-pin   | <b>573194</b>              | <b>VAVE-C8-1R1</b>          |  |
| <b>Connecting cable, socket M8x1</b>  |  |  |  |                            | Datasheet → Internet: nebu  |  |
|  | Socket M8x1, 3-pin                               | Straight   | Open cable end 3-wire  | Length 2.5 m               | <b>541333</b>               | <b>NEBU-M8G3-K-2.5-LE3</b>                 |
|   |  |  |  | Length 5 m                 | <b>541334</b>               | <b>NEBU-M8G3-K-5-LE3</b>                   |
|   |  |  |  | Length 2.5 m               | <b>541348</b>               | <b>NEBU-M8G3-K-2.5-M8G3</b>                |
|   |  | Length 5 m   | <b>541349</b>  | <b>NEBU-M8G3-K-5-M8G3</b>  |                             |  |
|   |  | Length 10 m  | <b>569844</b>  | <b>NEBU-M8G3-K-10-M8G3</b> |                             |  |
|   |  | Angled   | Open cable end 3-wire  | Length 2.5 m               | <b>541338</b>               | <b>NEBU-M8W3-K-2.5-LE3</b>                 |
|   | Length 5 m                                       |  |  | <b>541341</b>              | <b>NEBU-M8W3-K-5-LE3</b>    |  |
|   | Length 2.5 m                                     |  |  | <b>541342</b>              | <b>NEBU-M8G4-K-2.5-LE4</b>  |  |
|   | Socket M8x1, 4-pin                               | Straight   | Open cable end 4-wire  | Length 5 m                 | <b>541343</b>               | <b>NEBU-M8G4-K-5-LE4</b>                   |
|   |  |  |  | Length 2.5 m               | <b>541345</b>               | <b>NEBU-M8W4-K-5-LE4</b>                   |
|   |  | Angled   | Open cable end 4-wire  | Length 2.5 m               | <b>541344</b>               | <b>NEBU-M8W4-K-2.5-LE4</b>                 |
|   | Modular system for a choice of connecting cables |  |  | Length 0.1 ... 30 m        | <b>539052</b>               | <b>NEBU-...</b><br>→ Internet: nebu        |

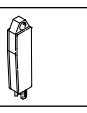
## Accessories

| Ordering data – Accessories for CPE18 and CPE24                                    |  |   |                  |                | Part no.                      | Type              |                  |  |
|--|--|---|------------------|----------------|-------------------------------|-------------------|------------------|--|
| <b>Plug socket with cable, socket type C to EN 175301-803</b>                      |  |   |                  |                | Datasheet → Internet: kmeb    |                   |                  |  |
|    | Cable sheath PVC                                 | Signal status indication with LED           | 24 V DC          | Length 2.5 m   | 151688                        | KMEB-1-24-2.5-LED |                  |  |
|  |  |   | 24 V DC          | Length 5 m     | 151689                        | KMEB-1-24-5-LED   |                  |  |
|  |  |   | 24 V DC          | Length 10 m    | 193457                        | KMEB-1-24-10-LED  |                  |  |
|  |  | Without indication                          | Up to 240 V      | Length 2.5 m   | 151690                        | KMEB-1-230-2.5    |                  |  |
| Up to 240 V  | Length 5 m                                       |   | 151691           | KMEB-1-230-5   |                               |                   |                  |  |
|    | Cable sheath PUR                                 | Signal status indication with LED           | 24 V DC          | Length 2.5 m   | 174844                        | KMEB-2-24-2.5-LED |                  |  |
|  |  |   | 24 V DC          | Length 5 m     | 174845                        | KMEB-2-24-5-LED   |                  |  |
|  |  | Without indication                          | Up to 240 V      | Length 2.5 m   | 174846                        | KMEB-2-230-2.5    |                  |  |
|  |  |   | Up to 240 V      | Length 5 m     | 174847                        | KMEB-2-230-5      |                  |  |
| <b>Plug socket</b>   |  |   |                  |                | Datasheet → Internet: mssd    |                   |                  |  |
|    | Socket 3-pin, type C to EN 175301-803            | Screw terminal                              | Up to 240 V      | 151687         | MSSD-EB                       |                   |                  |  |
|  |  | Insulation displacement connector           | Up to 240 V      | 539712         | MSSD-EB-M12                   |                   |                  |  |
|  |  |   | Up to 240 V      | 192745         | MSSD-EB-S-M14                 |                   |                  |  |
| <b>Illuminating seal</b>   |  |   |                  |                | Datasheets → Internet: meb-ld |                   |                  |  |
|    | Type C to EN 175301-803                          | 12 ... 24 V DC                              | 151717           | MEB-LD-12-24DC |                               |                   |                  |  |
|  |  | 230 V AC                                    | 151718           | MEB-LD-230AC   |                               |                   |                  |  |
| <b>Ordering data – General accessories</b>   |  |   |                  |                | Part no.                      | Type              | PU <sup>1)</sup> |  |
| <b>Blanking plug</b>   |  |   |                  |                | Datasheet → Internet: b       |                   |                  |  |
|  | For manifold block CPE10                         | G1/4 thread                                 | 3569             | B-1/4          | 10                            |                   |                  |  |
|  | For manifold block CPE14, CPE18                  | G3/8 thread                                 | 3570             | B-3/8          | 10                            |                   |                  |  |
| <b>Separator for pressure zones</b>  |  |   |                  |                | Datasheet → Internet: vabd    |                   |                  |  |
|  | For manifold block CPE14, CPE18                  |   | 160997           | PRSV-1/8       | 1                             |                   |                  |  |
| <b>Silencer</b>  |  |   |                  |                | Datasheet → Internet: uc      |                   |                  |  |
|  | Thread   | M3  | 1231120          | AMTE-M-LH-M3   | 20                            |                   |                  |  |
|  |  | M5  | 165003           | UC-M5          | 1                             |                   |                  |  |
|  |  | M7  | 161418           | UC-M7          | 1                             |                   |                  |  |
|  |  | G1/8  | 161419           | UC-1/8         | 1                             |                   |                  |  |
|  |  | G1/4  | 165004           | UC-1/4         | 1                             |                   |                  |  |
| <b>Manual override</b>   |  |   |                  |                | Datasheet → Internet: ahb     |                   |                  |  |
|  | For CPE10 and CPE14 with plug pattern ZC         |   | 157600           | AHB-MZB        | 1                             |                   |                  |  |
|  | For CPE18 and CPE24 with plug type C             |   | 157601           | AHB-MEB        | 1                             |                   |                  |  |
| <b>Inscription labels</b>  |  |   |                  |                | Datasheet → Internet: ibs     |                   |                  |  |
|  | Inscription label, 6x10 mm                       |   | 18576            | IBS-6x10       | 64                            |                   |                  |  |
| <b>Mounting kit</b>  |  |   |                  |                | Datasheet → Internet: davm    |                   |                  |  |
|  | With mounting bracket for lateral valve mounting | For standards-based cylinders DSBC-32...40  | For CPE14        | 2568514        | DAVM-MW-V1-32-V               | 1                 |                  |  |
|  |  | For standards-based cylinders DSBC-50...125 | For CPE18, CPE24 | 2612128        | DAVM-MW-V1-50-V               | 1                 |                  |  |

1) Packaging unit.